

Wireless World

SEPTEMBER 1951

VOL. LVII. No. 9.

National Radio Exhibition

IN this issue we publish, in semi-graphical form, a guide to the 18th National Radio Exhibition, which, it is hoped, will help not only readers who are actually visiting the show, but those who wish to keep informed of the current activities of those branches of the industry represented there. As will be seen, manufacturers of domestic broadcast and television receivers are very much to the fore; indeed, in this section the exhibition may be regarded as fully representative. The same cannot, unfortunately, be said of other branches of our art, though, as at the Castle Bromwich show last year, few are entirely without representation. Although the manufacturers' exhibits lean so heavily towards broadcasting, displays staged by Government departments and other non-commercial organizations are planned to show the visitor what is going forward in communications, electronics and many other applications of radio.

Television promises to be the greatest attraction, if only for the reason that the planned opening of two more B.B.C. stations during the next few months will go a long way towards providing complete coverage of the country.

New Broadcasting System?

WE suggested last month that there was little in the White Paper on the Beveridge Report to stimulate discussion on matters within our province. That opinion seems to have been justified, but, in the Parliamentary debate on the White Paper, the Postmaster General made a rather cryptic statement that, several weeks after the event, is still the subject of speculation in radio circles. Referring to v.h.f. broadcasting, the P.M.G. said, in effect, that an "entirely new" system of modulation had come to light, which might well supplant both f.m. and a.m.; this new system must be examined before any decision is made on a national system of v.h.f.

The natural reaction to this statement is "What is it?" and the P.M.G.'s reasons for failing to answer that simple question are singularly unconvincing.

There seems to be no good reason why we should not be given the facts, nor why the origin of the recommendation made to the Post Office should not be disclosed. As things are, there is a general feeling of uncertainty, mixed with a good deal of scepticism as to the real novelty of the mysterious system. The majority opinion inclines, naturally enough towards some form of pulse modulation, and this is the basis on which a contributor speculates elsewhere in this issue.

Wireless World has long urged that most careful thought should be given to the planning of our v.h.f. service, and, above all, that we should not be stampeded into making a wrong choice of system. Every possible system should be examined, but the P.M.G.'s present smoke-screen tactics can only increase still farther the delay in coming to a decision.

Illegal Interference

CONTRARY to popular opinion, man-made interference with radio reception did not automatically become illegal on the passing of the Wireless Telegraphy Act, 1949. The anti-interference clauses of the Act remain ineffective until such time as the Postmaster General, acting on the advice of a duly appointed body, makes specific regulations.

The first real step towards outlawing avoidable interference has now been taken, and it may justly be regarded as a milestone. An advisory committee has been dealing with the question of radiation from the ignition systems of internal combustion engines and its effect on television reception. Specific recommendations have been made concerning the limitation of the radiated field of interference. The next step is for the P.M.G. to issue a statement on the action he proposes to take on the making of regulations. It is not until these regulations are actually made that interference will be, for the first time, legally preventable in Great Britain. At the present rate of progress, how long will it be before all forms of serious interference are outlawed?

Many other sources have yet to be dealt with.

Photograph of the underside of the chassis showing the position of all the parts. Terminals for aerial and earth leads are at one end and those for the headphones at the other. Nothing is mounted on top of the chassis.

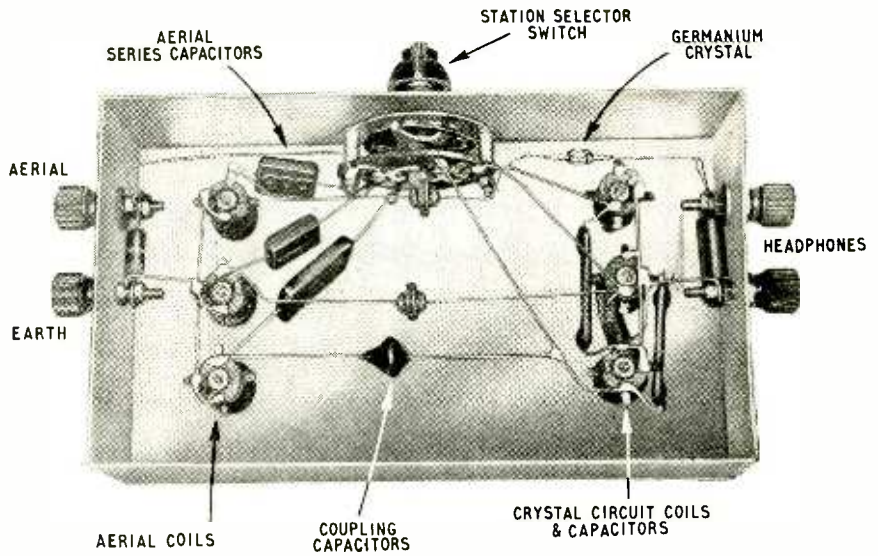

A Modern Crystal Set

Pre-Selection of Three Stations to Suit Local Conditions

By B. R. BETTRIDGE*

THE advent of power cuts has forced many people to consider the crystal receiver as an alternative for programmes they particularly wish to hear, and the development of sensitive and robust permanent detectors has eliminated the nuisance of crystal adjustment. The crystal receiver is also gaining popularity as an alternative source of programmes for invalids and for children in bed.

The design of even so elementary a device as a crystal set is not so obvious as might be expected and there is room for wide divergencies of opinion as to what constitutes the best arrangement. The author was astonished at the amount of interest shown by colleagues and other friends with whom the matter was discussed and is grateful for their numerous suggestions.

A few basic requirements were taken as a starting point. They were: good performance on three programmes, moderate size, employment of standard components and simplicity of construction and operation. This meant that the possibly ideal arrangement for sheer performance, employing large diameter tapped coils wound with stranded wire could not be considered. It was also decided that the set should be primarily a fixed affair. The ability to take it from place to place and attach it to any aerial without adjustment was regarded as not worth the complication or sacrifice of performance which it would entail.

Most designs have a large element of compromise and this was no exception. As a general rule, however, when compromise had to be made the most important factor was deemed to be signal strength. This may seem strange considering the enormous increase in power of stations since the early days, but there are two other points to consider. The first is that people no longer look upon minute signals as acceptable and now demand what at one time would

have been regarded as very loud signals in the "phones on the table" category. The other, the inescapable fact that the only power available is that derived from the aerial and big aerials are out of fashion.

The question of good signal strength has particularly to be watched when meeting the need for reasonable selectivity since to some extent the two requirements are conflicting. The degree of selectivity needed varies according to area, but to suit the majority of users a two-circuit tuner is essential. This, without critical design or adjustment, gives considerably better station separation without undue sacrifice of strength than the most carefully designed single-circuit set. Incidentally, in assessing selectivity requirements account must be taken of various powerful stations situated about the country giving special services to Europe. No details of these transmissions appear to be

TABLE OF VALUES

Station	Aerial Circuit		Crystal Circuit		Coupling C in pF
	Coil	Series C in pF	Parallel C in pF†	Coil	
L. W. Light (1,500m)	HH1	1,000	200	HH2	1,500
Third (464m)	HH2	300	150	HH3	350
Northern (434m)	HH2	300	100	HH3	300
Scottish (371m)	HH3	400	200	HH3	250
Wales (341m)	HH3	250	150	HH4A	1,000
London H. (330m)	HH3	200	150	HH4A	900
West (285m)	HH3	200	100	HH4A	700
Midland (276m)	HH3	150	100	HH4A	650
N. Ireland (261m)	HH3	150	80	HH4A	600
London L. (247m)	HH3	100	70	HH4A	500
West Local (206m)	HH3	70	50	HH4A	330
Third Local (194m)	HH3	70	40	HH4A	300

* Osram Valve & Electronics Dept., G.E.C.

† For modified circuit only.

generally available but they make their presence known in a very definite fashion in some areas. It is not anticipated that higher selectivity than that given by the standard arrangement will often be needed, but modifications will be mentioned for the benefit of those unfortunately placed.

The circuit finally adopted after numerous trials is shown in Fig. 1. It will be seen that station selection is by switching and that each station has its own pair of coils individually tuned and coupled. This arrangement has two distinct advantages besides extreme simplicity of operation. In the first place there is no ganged tuning to impose limitations on the circuit and in the second place optimum values may be chosen for each station instead of compromising between the requirements of different parts of the waveband. Thus instead of performance being sacrificed for the sake of simple operation it has in fact been improved.

Even if the design had not been started with commercial coils in mind this circuit would have made them almost essential, since six home-made coils of reasonable efficiency are apt to take up a lot of space. The coils used are wound with stranded wire and have adjustable dust iron cores. In spite of their small size they have "Q" values of over 100.

The aerial circuit is series tuned, an arrangement which is now uncommon in any but transmitting circuits but which gives greatest signal strength in the simplest way with the majority of aerials likely to be used for crystal reception. The modern method of aerial coupling widely used in valve receivers consisting of a high impedance aerial coil is quite unsuitable for crystal working because of its poor power-transfer efficiency. The other common form of coupling consisting of a low impedance coil or tap on the tuned circuit is better, but big deviations from optimum occur with different aerials unless several taps are provided. It will be noted that the coils used are actually h.f. transformers and the primary windings can be used for this form of coupling in special cases. Typical values of series capacitance are quoted but these may have to be modified for aerials differing greatly from that for which the set was designed. This slight disadvantage in setting-up procedure is amply compensated by the greater signal strength resulting from a correct matching.

Coupling between the circuits is by top capacitance. The value to be aimed at is the critical coupling which

gives maximum strength without double humping. It cannot be exactly specified since some of the factors affecting it vary from one set to another, in particular the aerial damping and the crystal load. A pre-set 0 to 30pF trimmer could be used by the meticulous but the typical values listed are unlikely to cause audible loss.

To feed the crystal a straightforward parallel tuned circuit is used. A tapped circuit might have been expected here, and indeed first experiments showed that with ordinary values, placing the crystal circuit across the whole of the coil produced so much damping as to cancel out most of the advantage of the double circuit tuner. To avoid having non-standard tapped coils made up, alternative means were explored such as a capacitance tap and a second crystal to complete the rectifier d.c. path. However, as often, the simplest means proved most effective and the equivalent of a matching tap was provided by lowering the impedance of the circuit by an unusually low L/C ratio. Thus a 390- μ H coil is used for 1,500 metres instead of the more usual one of 2,650 μ H, whilst the coil for the lower end of the broadcast band is 35 μ H instead of 178 μ H. A stranded wire version of the Weyrad HH4 coil, called the HH4A, is used here, this single minor departure from standard being preferable to the introduction of several tapped coils.

Germanium Crystal

The crystal used is one of the new germanium diodes which are already finding wide application in electronic gear generally. Many of the specialized types now available are selected for characteristics which are not important in a crystal receiver, and several of the standard types will give good performance in this set. For general purposes the G.E.C. type GEX35 will be found satisfactory, but where maximum sensitivity is desired a low level rectifier such as the GEX64 or GEX66 should be used. Where maximum selectivity is desired, a high impedance rectifier such as the GEX44/1 or GEX45/1 will give optimum performance.

Headphones of 4,000 ohms resistance can be fed direct or low-resistance ones can be operated via a suitable transformer, the impedance for matching purposes being taken as about 15,000 ohms. The precise value varies with signal so cannot be specified, but it is by no means

critical. While the quality of reproduction which may be obtained from a crystal receiver is extremely good, the cheaper patterns of diaphragm headphones have a restricted frequency response and marked resonances which colour the reproduction. This is particularly noticeable when signal strength is high. Where better quality

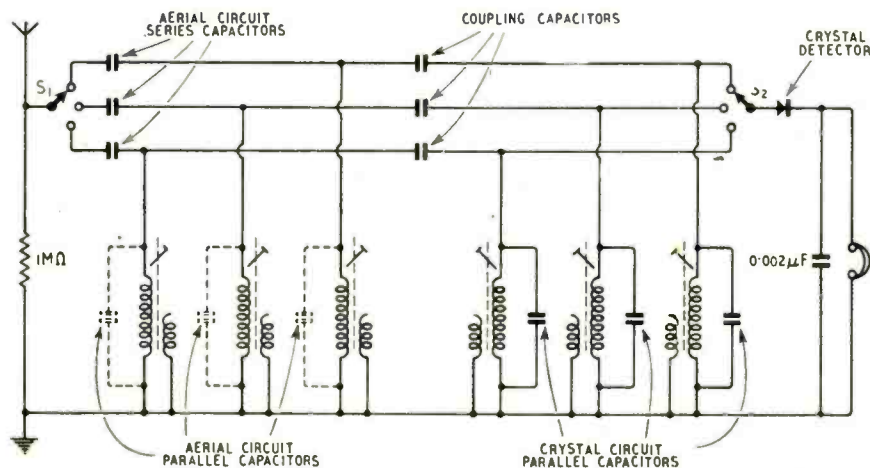

Fig. 1. Circuit diagram of the crystal set. Values of the series and parallel fixed capacitors depend on the three stations required and they are given in the table. The aerial circuit parallel capacitors (shown dotted) are required only under the conditions explained in the text.

is desired the moving coil type of headphone is advantageous. ☉

It is suggested that wherever possible an outdoor aerial should be used. This need not, however, be the elaborate affair of the old days, consisting of thick stranded wire and strings of heavy insulators. The main point is that it should be strong enough to withstand the weather. Within ten to twenty miles of a powerful station a loft aerial will give reasonable results, but it should be as long and as high as the house permits. Except in districts very near to a station the picture-rail type of aerial is quite certain to be disappointing. A 1-megohm resistor is shown connected between aerial and earth to avoid accumulation of static since the circuit provides no other direct path. Measurements show that a low resistance earth connection is really important, and a clip on a cold water pipe is one of the most satisfactory solutions.

The photograph shows how the set is made up. This construction was adopted so that it could be fixed permanently in an inconspicuous position such as under a window ledge with the phones hanging on a nearby hook. The chassis used is a readily obtainable standard size, but clearly a much smaller one could accommodate the components and could be used to suit individual tastes. The actual wiring is sufficiently obvious from the photograph of the underside of the chassis to need no detailed description. Type numbers of coils and values of capacitors for various stations are given in the table. The adjustable dust cores should give sufficient range to cope with the normal ± 20 per cent capacitor tolerance. As far as possible values have been chosen which are readily available, but in case of difficulty a value can, of course, be made up by connecting two or more in parallel.

The lining-up of the set is not difficult, but since tuning is fairly sharp some guidance may be helpful. The capacitance values given in the table are calculated to tune to the station required with the core near the mid position. Clipping the aerial temporarily on to the primary winding (green tag) of the crystal circuit and turning the set into a single circuit tuner is probably the quickest way of getting a tuning point on this coil. The aerial can then be transferred to its proper terminal and the aerial coil brought to resonance. After this the crystal coil should be re-trimmed. Should the aerial coil not peak a different value of series capacitance should be tried. The values listed are for an aerial about 80 ft long and 20 ft high; a larger one may require a smaller value and *vice versa*. In the case of very small aerials some parallel capacitance may have to be added across the coil to produce resonance, as shown in dotted lines in the circuit diagram Fig. 1. The process is repeated for each pair of coils, after which tuning from one station to another consists merely of rotating the switch.

The basic arrangement described above allows of certain variations which may be worth trying in some circumstances. The first is using the primary coil for aerial coupling. In this case parallel tuning of the aerial coil is necessary and appropriate values of capacitance are given in the table. An alternative is to couple these parallel-tuned coils to the aerial via a small capacitance, the actual value depending on circumstances. This constitutes a very flexible arrangement, especially useful for highly damped aerials, but in general severe loss of signal strength is

entailed. Yet another variation is to use the primary coil of the crystal circuit as a secondary to feed the crystal. This gives very low damping at considerable expense of signal strength. It is perhaps worth mentioning that those who require two programmes only need fit only the appropriate two pairs of coils, whilst those in London who wish to have the Light Programme available on both wavebands will easily find room for an additional pair of coils. This was in fact done in the prototype to facilitate checking its performance.

Tests were made at a number of places in the London and Midland areas, results being compared by taking readings on a micro-ammeter in series with the phones. Variations due to local conditions were greater than had been anticipated, and it was surprising to find that in some parts of London the 1,500-metre Light Programme provided a greater signal than the Brookmans Park transmission of the same programme. It is a matter of opinion as to what constitutes acceptable strength, but even $5 \mu\text{A}$ gives a signal that enables programmes to be followed perfectly in a quiet room. Probably the minimum comfortable level is about $20 \mu\text{A}$. Where readings above $100 \mu\text{A}$ are obtained programmes can be followed on a sensitive loudspeaker in quiet surroundings. One of the highest readings obtained was over $400 \mu\text{A}$ from an aerial on top of the *Wireless World* building, this figure being given by the Home Service.

A precise list of parts is not specified since, in general, constructors will wish to use components available locally. It is sufficient to mention the following points:—

The chassis measures $7\text{in} \times 4\text{in} \times 2\text{in}$; the switch is a 2-pole 3-way "Yaxley" type; the coils are Weyrad "H" type and the crystal is a G.E.C. germanium diode.

ACCESSIBILITY

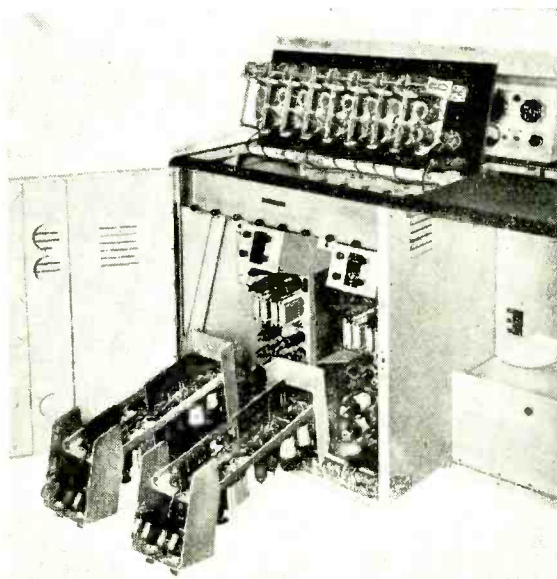

This view of the Ediswan 8-channel electro-encephalograph is an example of the growing tendency to design equipment with an eye to easy maintenance.

Mystery Broadcasting

THOMAS RODDAM Speculates on What the P.M.G. Meant

THE latest pronouncement on v.h.f. broadcasting appears to have been drafted by a student of the works of Franz Kafka and of Lewis Carroll. It lays down the future plans with all the precision of a charabanc poster advertising a mystery tour. Let us consider what the Postmaster-General said.

"Research has discovered an entirely new consequence, which completely sets aside all the reasons for giving favour to one or the other" * [a.m. or f.m.]. Can this possibly be true, in the engineering sense, not the political? If it is true, what can this "entirely new" thing be? I am, fortunately, in a position to reveal to readers of *Wireless World* a sensational possibility. In an article (July, 1945), "Radiophare" discussed telepathy and suggested that radio engineers would do well to conduct more experiments on the transfer of ideas. Shortly after this article appeared a lady, whose name I have unfortunately forgotten, got into communication with me and revealed that a certain Foreign Power was, in fact, well advanced in this field, and was engaged in putting ideas into people's heads, all unbeknownst. My own studies, carried out on a number of bathing beaches, showed that some individuals certainly possess a capacity to introduce a common idea into a number of independent heads.

I am afraid that this possibility, although no odder than some engineering proposals which have been studied at a high level, does not rank as Roddam's nap for to-day. If for one reason only, it must be eliminated: the Chancellor of the Exchequer would not be able to get his 15 per cent from telepathy. We must think again.

"Research has discovered . . .", and in a fortnight, too. That fortnight, like the thirteenth stroke of a crazy clock, casts doubt on all that has gone before. Not even a new system of colour television can be developed in a fortnight. My interpretation of this is that a gentleman from the Ministry has been reading departmental files and back numbers of *Wireless World*. He has worked back to February, 1947, when an obstinate scribe was advocating the use of pulse modulation, although Mr. Herbert Morrison had promised, in 1946,† "detailed plans for the establishment of f.m. stations . . . within a year or so." Yes, in 1946.

The case for frequency modulation was really that they have it in America, but that is in another country, and besides . . . The case against f.m. must now lay great stress on the financial side. We need completely new receivers for f.m. reception, and if we are to reap any real benefit from v.h.f. they must be good receivers. My guess is you will be lucky to get out

under £40 for a commercial f.m. receiver which gives that high-fidelity performance we are promised. A lot of money, a lot of design effort, a lot of components to be taken from the limited national supply for slightly improved entertainment. For the moment, amplitude modulation would let us have good reception with cheap converters and our present receivers, and we could buy high-fidelity sets later.

This case against f.m. is a case against pulse modulation, too. I still believe that pulse modulation is the final answer to the v.h.f. broadcasting question, and I am afraid that I have converted the P.M.G. just at the moment when expediency makes me hesitate. And Mr. Ness Edwards is no Duke of Wellington, to say "expediency be damned."

Pulse modulation, for broadcasting purposes, will probably be pulse position modulation. A typical scheme would be one using 30,000 pulses per second, each pulse lasting 1 microsecond. A transmitter having a mean power of 1kW would then radiate 33kW during pulses and would be received as a 33kW transmitter. The modulation is applied to the pulse epoch: that is, the pulses are advanced or retarded slightly from the exact 33.3 μsec spacing, according to the modulation. They might, for example, be moved 1-2 μsec at 100 per cent. modulation. This would be an extravagant scheme in band-width, for it would need a 2-Mc/s band: band-width could be saved by using longer pulses, with a smaller duty ratio. When a second programme is provided, a new train of pulses is interlaced with the first, and a gate circuit in the video section of the receiver (they call it video in the pulse world) is used to select the wanted programme. A common r.f. and i.f. head can supply two video systems, so that you can have both programmes from one lot of v.h.f. receiver equipment. The advantage of the pulse system is that there is no tuning: the r.f. circuits can be pre-set and drift-proof. Pulse modulation offers a considerable gain in signal-to-noise ratio, and is better in this respect than f.m. Furthermore, an approximate calculation suggests that it will be much better under multi-path propagation conditions: you will not get unbearable distortion when the local gas-holder is full. But we must still buy a complete new receiver.

Perhaps I can at least dispel the mystery within the mystery of the P.M.G.'s statement. He cannot indicate the nature of the new development, because it has not been tested and proved. How on earth does he imagine a new broadcasting system can be tested in secret? And why? Security is becoming such an obsession in some quarters that we shall soon have our programmes scrambled. This blanket is debasing the idea of secrecy: everything, classified and unclassified, is becoming "fairly secret."

* Hansard 20 July 1951.

† Hansard 16 July 1946.



Preliminary trials on a 5-ft diesel-powered model (Electronic Developments) with which it is hoped to cross the Channel. This and many other radio-controlled models are at present on show at "The Model Engineer" Exhibition at the New Royal Horticultural Hall, Westminster, where radio telearchics is a prominent feature this year.

Radio Telearchics

Outlining Some of the Principal Systems

PROBABLY one of the earliest radio telearchic systems was that demonstrated at the Paris Exhibition of 1906, when Professor Branly, using his famous coherer, showed how apparatus could be switched on and off at a distance. This was about the limit of the simple wireless equipment of those days, but with the development of new radio techniques control systems have become more and more versatile, until now they can convey and reproduce at the receiving end almost any kind of manual operation. Flying an aircraft by remote control, for instance, has become quite a commonplace affair.

This seems to imply a bewildering variety of complex systems in use nowadays. From the functional point of view, however, there are only two basic types: *selecting systems*, which convey different orders, like "start" and "stop," and *positioning systems*, which convey the different degrees of an order, as necessary, say, for turning a rudder. Many of the systems met in practice, of course, are not just simple selecting or positioning systems but combinations of the two.

To begin with selecting systems, perhaps the most elementary kind is that in which the orders can only be given in a certain sequence. The orders are transmitted as impulses, and at the receiving end these are arranged to operate a selector or stepping switch

so that with each impulse the wiper moves on to a new contact and completes an associated control circuit. If the selector has a ring of, say, four fixed contacts, orders can only be given in the sequence 1, 2, 3, 4, 1, 2, 3, 4, 1, 2 . . . etc., so to get from, say, order 3 to order 2 it is necessary first to pass through orders 4 and 1.

Such a system has the great virtue of simplicity and, because the weight of apparatus at the receiving end can often be reduced to a matter of ounces, it is used very widely in radio-controlled models. The fundamental disadvantage of having to pass through a whole sequence of orders before getting to the right one does not always matter, as this can usually be done so quickly as to make little difference. A worse drawback is that the operator must always remember the last order given if he is to calculate the right number of impulses to the next one he wishes to give. This can become very confusing, so the system is really only suitable for handling a short sequence of orders which can be memorized easily.

With a slightly more complex version of the same system these inherent disadvantages can be avoided. For instance, the selector can be fitted with a homing device that will automatically return the wiper to the same initial position after the completion of each order. Then, each order is represented by a definite number of impulses and a code is formed. With this arrangement it is possible to use some device such as a telephone dial for generating impulses at the transmitter, as this can be made to send the right number automatically when the order is dialled. Another refinement can

be added to prevent the wiper from actuating all the intermediate control circuits as it travels to its final position. This can be a slugged relay, which operates to break the circuit of the wiper so long as impulses are being received and the wiper is travelling, then, when the impulses cease and the wiper comes to rest, falls back and so completes the required circuit.

Whatever form the sequential system may take, however, it is inherently rather slow in operation, and this makes it unsuitable for such uses as the control of high-speed

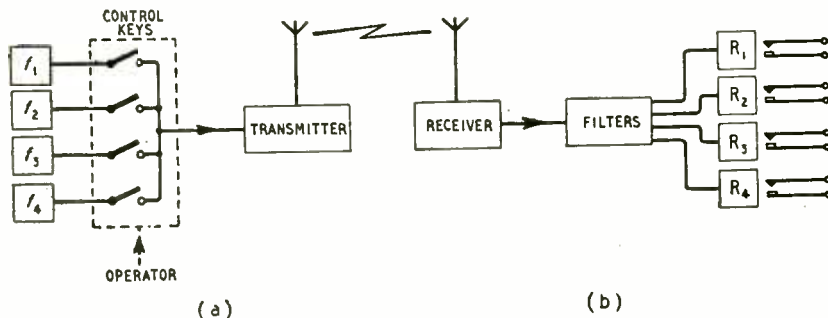

Fig. 1. Selecting system using modulating tones to provide the various control channels. At (a) the transmitter and (b) the receiver.

aircraft. For an almost instantaneous response probably the best system is the multi-channel type in which the orders are conveyed as different frequencies. In one form, the orders are transmitted as different radio frequencies and these are sorted out at the receiving end by means of r.f. tuned circuits and detectors, the outputs of which actuate relays. This, of course, amounts to a separate receiver for each order, but a modified scheme has been proposed requiring only one r.f. tuned circuit and detector. The tuned circuit has a variable tuning capacitor which is rotated continuously so that the incoming frequencies—whenever they are transmitted—are tuned in sequentially, or sampled, before passing to the detector. The resultant detector output voltages are then distributed to the correct relays by a rotary switch driven in synchronism with the capacitor.

Even with such modifications, selecting systems using different carrier frequencies tend to be unwieldy in design—and, of course, they occupy a great deal of space in the frequency spectrum. It is more convenient to use a single carrier frequency with a number of modulating tones to represent the orders, and this system is, in fact, very widely used for control purposes. Little explanation is necessary, for the mode of operation can be seen almost at a glance from Fig. 1. At the transmitting end (a) the modulating tones are generated by the oscillators f_1, f_2 , etc., and are selected for modulating the transmitter by a suitable switching arrangement. After being received and demodulated at (b) the tones are identified by a bank of filters; the output of each filter is then passed to a rectifier so that when the correct tone arrives it produces a d.c. voltage, which actuates a relay. A common practice is to include the relay in the anode circuit of a cut-off valve and apply the d.c. voltage to the grid in a positive sense to overcome the negative bias.

Besides being almost instantaneous in operation, the multi-channel system has the further advantage that several orders can be given at the same time. This feature is useful in another way. It means that the number of orders possible is not limited to the number of single tones available, since additional orders can be formed by combinations of tones. At the receiving end the contacts of the relays can then be interconnected in such a way that the transmission of tone combinations will bring into operation new circuits which are quite independent of the individual tones.

For installation in models, however, the receiving system in Fig. 1 usually proves too heavy and expensive, mainly because of the filters and the electronic apparatus necessary to work the relays. As an alternative, it is possible to use electromechanical frequency-responsive devices, which can be made much lighter than the equivalent electrical systems. A set of vibrating reeds, for instance, can be made to resonate with the various incoming frequencies by means of an energizing coil fed straight from the receiver. As each reed resonates it vibrates against a fixed contact and interrupts an external circuit, thereby generating impulses which can be made to charge a storage capacitor and so produce a steady voltage for operating a relay. Although it is the physical properties of the reeds which actually do the responding, improved selectivity can sometimes be obtained by electrically tuning the inductance of the energizing coil to the frequency band occupied by them. A device working on a very similar principle is the resonant relay.

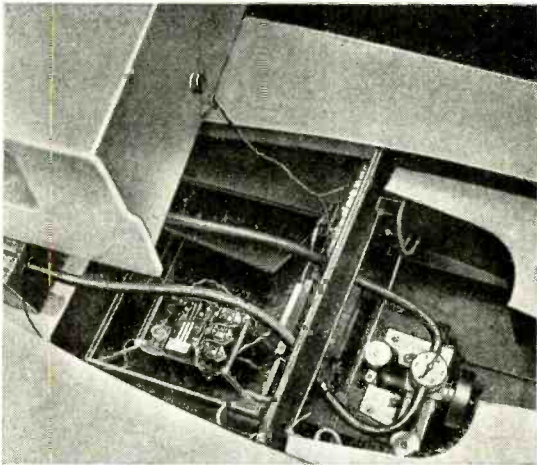

Interior of the 5-ft E.D. model. The 4-stage receiver (left) uses deaf-aid valves and drives a tuned-reed selecting system with three reeds working between 300 and 350 c/s. These switch the steering motor to port or starboard and sound a horn. The transmitter uses 100% square-wave modulation.

Here the armature is a permanent magnet held in position by a hair spring, and this oscillates backwards and forwards like the balance-wheel of a clock whenever the input to the energizing coil corresponds to the natural frequency of the mechanism.

Now to positioning systems. As mentioned before, these are for conveying different degrees of an order and enabling progressive adjustments to be made to a distant control mechanism. One of the simplest is that sometimes used for controlling the rudder movement of light craft, where very little mechanical power is needed. The actual driving mechanism is an electromagnetically-operated pawl and ratchet or an escapement, and this is stepped round by means of impulses from the transmitter.

With heavier craft, where considerable power is needed to apply helm, it becomes necessary to drive the rudder through reduction gearing from a rever-

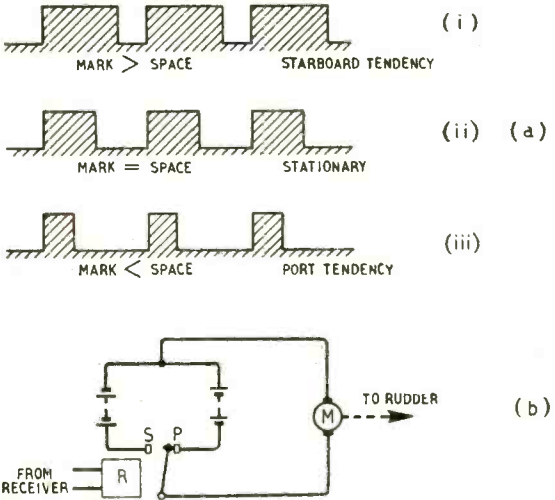

Fig. 2. Positioning system working on variations of pulse-width ratio, suitable for rudder control. The transmitted pulses (a) after being received are fed into the control mechanism (b).

sible electric motor—so that one order is needed for port helm and another for starboard helm. In its simplest form, however, this is not a very precise method of positioning, since the angle finally taken up by the rudder depends on the time the steering motor is running and so cannot be determined very accurately. There are, however, a number of improved versions of the basic idea and these provide the operator with a much better measure of control. One is a development of the time-switch principle in so far as the duration of the signal controlling the steering motor is adjusted automatically for the required rudder position—that is, not the duration of the signal in absolute time, but the ratio between the mark period and the space period in a train of square pulses. Fig. 2(a) shows how the pulse-width ratio is varied.

At the receiving end (b) this train of pulses is made to operate the relay R, which, as can be seen, determines the direction of the steering motor. During a mark the armature is pulled over to the contact S and the rudder moves to starboard; during a space the armature falls back on to the contact P and the rudder moves to port. Thus, if the mark/space ratio is 1:1 as in (ii), the rudder will move equal amounts in both directions and, if the reduction gearing between motor and rudder is sufficient and the pulse repetition frequency is great enough, it will remain stationary for all practical purposes. If broad pulses are transmitted as at (i) the rudder will progressively move to starboard, and if narrow pulses are transmitted as at (iii) it will move to port. And the greater the mark/space ratio the faster the rudder will move. To maintain the rudder in any particular position it is only necessary to revert to the 1:1 condition as at (ii). At the transmitting end the pulse generator can take the form of a vibrating relay, and there must, of course, be some means of continuously varying the pulse width.

The main disadvantage of the system is that the signal cannot be removed without sending the rudder to one extreme or the other. Moreover, the steering motor is necessarily consuming current all the time.

Another method of controlling the steering motor enables the operator to determine not merely the position of the rudder but the actual compass course that he wishes the craft to take. It involves a form of automatic pilot, controlled by a gyroscope, that maintains the craft on whatever course has been set. Referring to Fig. 3 (a), a constant-course heading is provided in the craft by a gyro-magnetic compass which maintains an electrical reference in the form of a pivoted contact arm, R. When the craft deviates from this heading, the gyro drives R into contact with one of the segments and thereby switches the steering

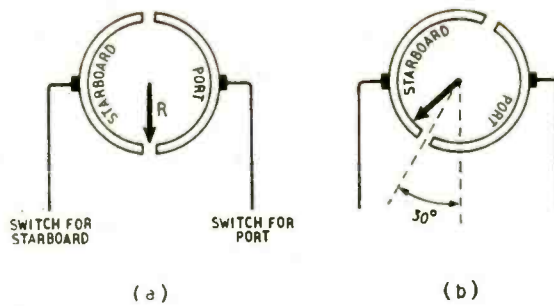

Left: Fig. 3. Part of a device for rudder positioning making use of the automatic-pilot principle.

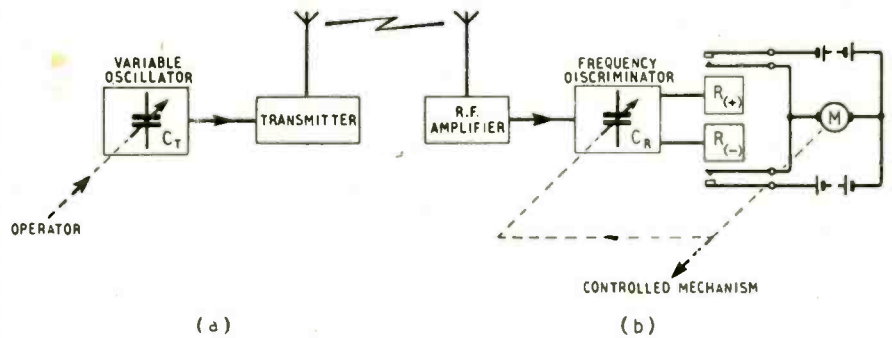

Below: Fig. 4. Servo positioning system working on variations of frequency: (a) the transmitter and (b) the receiver.

motor in the right direction to correct the deviation. When the craft has swung back on course again the reference arm R returns to the neutral position between the segments and so switches off the motor.

Steering is achieved by transmitting an order which deliberately rotates the segments the required number of degrees with respect to the arm R (30° to port in Fig. 3(b)). As the craft commences to turn the gyro swings with respect to it and so causes R to follow-up the rotation of the segments. When the craft has almost completed the order the gyro has swung through an equivalent angle but the gearing between it and R is arranged so that R has actually overtaken the neutral gap (Fig. 3(b)) and is now on the starboard segment. As a result the rudder begins to return to amidships, and the craft finally settles down on to its new course with R back in the neutral gap.

The initial rotation of the segments is achieved by a stepping mechanism which is operated by impulses from the transmitter—so many degrees being represented by each impulse.

From the description of the above system readers will no doubt recognize that a servo or follower principle is involved by the fact that "error-signals" are produced by deviations from course or by steering. These error-signals are of a mechanical nature and consist of deviations from a mechanical norm R that exists at the receiving end of the system. There are, however, other kinds of servo systems used in telearchics, and one of the most common and easily recognized is that where the error-signals are electrical deviations from an electric norm established at the transmitting end. In other words, a change deliberately introduced in the transmitted signal produces an error-signal at the receiver, and the servo or follow-up mechanism works by continuously and automatically adjusting itself so that this error-signal is balanced out. There are several ways of producing the continuously variable change required in the transmitted signal—by varying the frequency, amplitude or phase—but the final effect is the same whatever method is used.

Fig. 4 shows, for example, the essentials of a servo position control working on variations of frequency. The transmitter (a) includes a variable-frequency oscillator, the frequency of which is varied in accordance with the degree of the order by means of the variable capacitor C_T . At the receiving end (b) a similar variable capacitor is used for tuning, and the object of the servo or follow-up mechanism is to keep the system constantly in tune with the varying incoming frequency by rotating the variable capacitor C_R so that any movements of the rotating vane of C_T are followed faithfully by corresponding movements of the rotating vane of C_R .

The variable capacitor at the receiving end is actually part of a frequency discriminator of the well-known type which gives zero voltage output when it is tuned exactly to the incoming frequency and positive and negative voltages when the incoming frequency is too low and too high. Now assume that an operator at the transmitting end has decreased the capacitance of C_T and thereby increased the transmitted frequency. The discriminator then becomes off tune and produces a negative voltage error-signal which, after rectification, closes the relay $R_{(-)}$. As a result, power is applied to the reversible motor M , which drives the rotating vane of C_R in such a direction as to decrease the capacitance. By doing this, it progressively brings the discriminator into tune with the increased frequency; and when the circuit is exactly in tune the output of the discriminator falls to zero, relay $R_{(-)}$ opens, the motor stops and the moving vane remains stationary. The whole system is now restored to a balance condition. In the same way, if the operator increases the capacitance of C_T , relay $R_{(+)}$ will cause the motor to increase the capacitance of C_R correspondingly until once again the system is

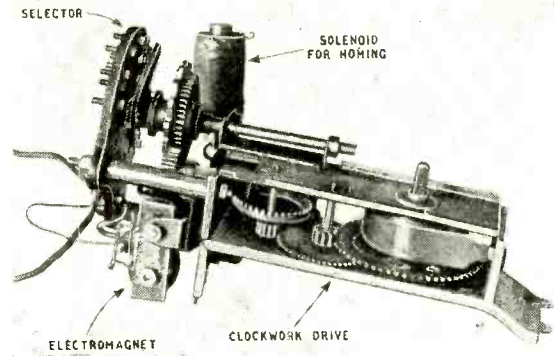

Sixteen-position selector operated by a clockwork-driven escapement which is tripped by an electromagnet. After each order, the selector is homed by a solenoid and slow-acting plunger; this operates fully when there is a pause after a series of actuating impulses. (Maker: N. A. Ough.)

restored to balance. It can be seen, then, that since the motor M is causing the rotating vane of C_R to follow closely every movement of the rotating vane of C_T , any mechanism driven by M will also follow the rotating vane of C_T —and any movements applied to C_T by an operator. The tuning control at the transmitting end can thus be calibrated in terms of mechanical displacement at the receiving end.

There are, of course, alternative methods of driving C_R . For instance, the incoming frequency can be keyed so that the discriminator will produce positive or negative pulses instead of d.c. voltages, these pulses being arranged at the correct frequency to drive a two-phase synchronous induction motor. Another ingenious system employs a simple series resonant circuit as the discriminator. Then, as the incoming frequency is varied above and below the resonant point, the phase of the current in the circuit either leads or lags with respect to the applied voltage, and these changes of phase constitute positive or negative error-signals which drive a two-phase motor in either direction. As in Fig. 4, the motor rotates a tuning element in the resonant circuit in such a direction as to bring the circuit back into tune with the incoming frequency and restore the system to balance.

The system working on variations of amplitude is similar in form. At the transmitting end the variable element is an attenuator, and a corresponding variable attenuator at the receiving end is kept in step with it by means of an amplitude-comparing circuit.

Positioning by means of phase variations is a rather

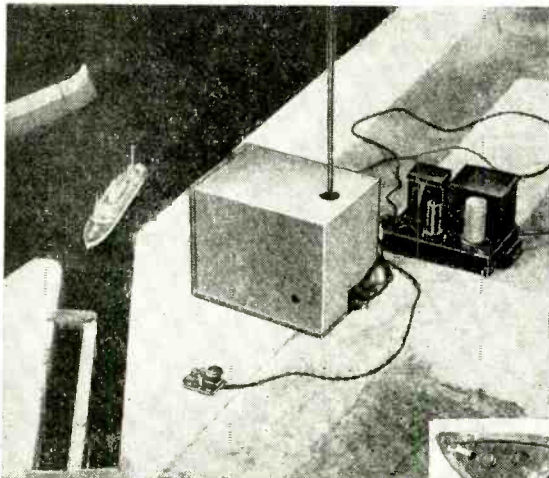

Used by civil engineers (Sir Bruce White, Wolf, Barry and Partners) for testing scaled-down harbour installations (above), this model boat is only 11.8in long. Pulses of r.f. on 27 Mcs are transmitted to operate the receiver (right), a self-quenching super-regenerative type using an XFG1 subminiature gas triode. A sequential selecting system gives four rudder positions with the aid of a rubber-driven escapement and enables the motor to be started, stopped and reversed.

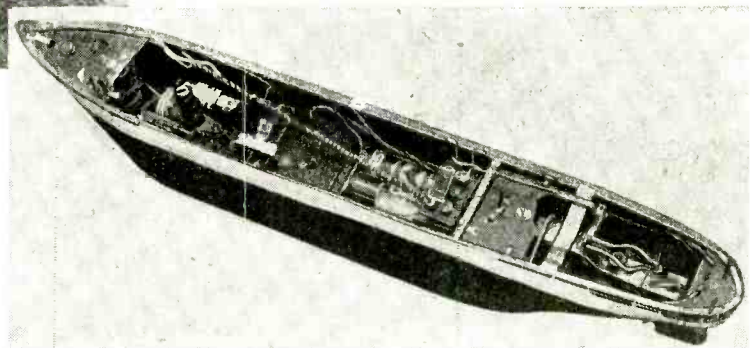

more complex matter, but an example of how it can be done is provided by a telearchic system developed by the General Electric Company for controlling high-speed aircraft in flight. Here, (Fig. 5), the conversion from mechanical movement into variations of phase is done by a phase shifter, PS_T , in the transmitter, and at the receiving end a servo system is arranged to drive a corresponding phase shifter PS_R such that the phase change initiated by PS_T is always reproduced by PS_R . Referring to (a), the frequency generator produces f_1 , one output of which provides the reference phase whilst the other output, after passing through PS_T , provides the controlling phase. These outputs — of the same frequency but different in phase — are then phase-modulated on to two separate sub-carrier frequencies, f_2 and f_3 , which, in turn, are amplitude modulated on to the carrier of the transmitter. At the receiving end (b) the sub-carriers f_2 and f_3 are filtered out and from them the two f_1 channels, differing in phase, are produced by demodulation in the phase discriminators. The f_1 control phase is now compared with the f_1 reference phase in a discriminator, after the latter has passed through PS_R . Any difference between them produces an error-signal in the form of a d.c. output which energizes the motor and so drives PS_R in such a direction as to eliminate the error signal. Looked at in another way, the balance condition of the servo is with f_1 (reference) in the same phase as f_1 (control); therefore PS_R works to neutralize exactly the phase difference introduced between the two at the transmitter and so moves through a corresponding angle to PS_T . The mechanical drive in (b) is then taken from the servo motor in the normal way.

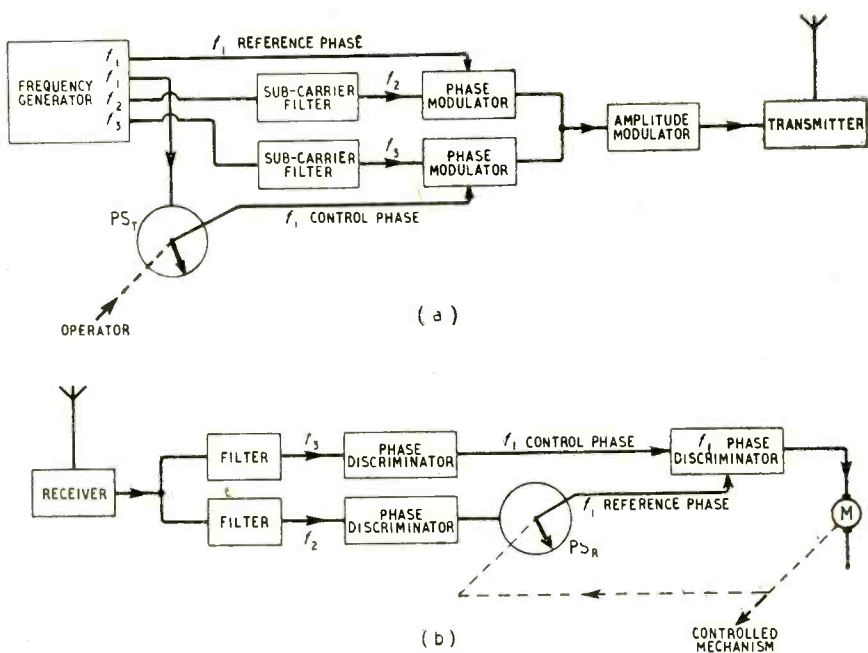
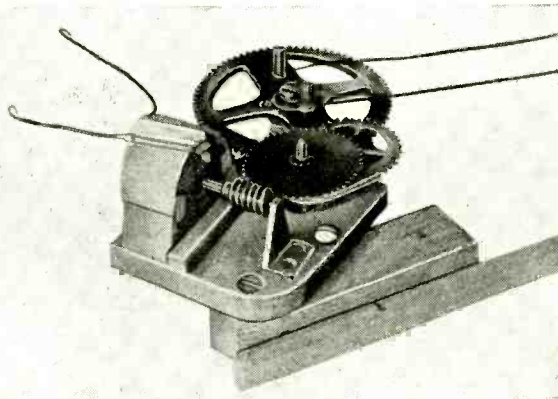
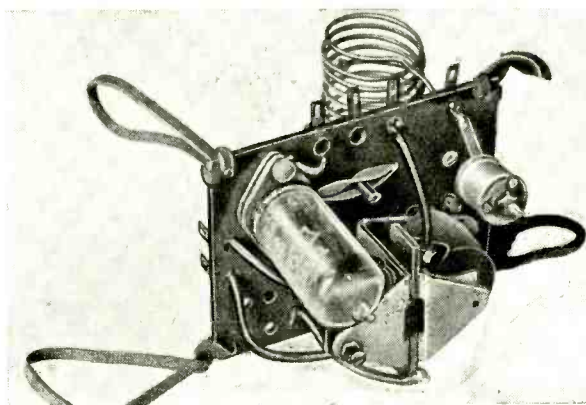

Fig. 5. Phase-shift servo positioning system in which a control phase is varied with respect to a reference phase: (a) the transmitter and (b) the receiver.

A feature of this system is that it enables a number of position-control channels to be operated on the one radio link. All that is necessary are additional pairs of phase shifters, corresponding to PS_T and PS_R , and additional sub-carriers (f_4, f_5, \dots etc.) to carry the new f_1 control phases. By using, say, two of these control channels for a single function it is possible to convey the information with great accuracy, as one control channel can be used as a kind of vernier on the other. The G.E.C. equipment actually contains seven control channels in all, together with the extra channel for the reference phase.

Finally, it goes without saying that combinations of the above basic systems can be used where a large number of different orders are required. One very convenient method is to provide a group of control channels by means of modulating tones, or sub-carriers, then each of these can be regarded as a radio link in its own right and used to carry a subsidiary system.

Left: Commercially made receiver for radio-controlled models. Right: Steering mechanism driven by a reversible electric motor (maker, N. A. Ough). The wires on the right connect to a rudder-bar.



Efficiency Line-Scan Circuits

Part 2—Diode Conditions

By W. T. COCKING, M.I.E.E.

AS an example of conditions with a directly-fed deflector coil the following figures were derived in Part I for a valve having a peak-anode current of 200 mA with a minimum anode-cathode potential of 95 V: $L_L = 22.3$ mH, $C = 1160$ pF, $r_r = 44.6 \Omega$, $I_L = 360$ mA and overshoot $x = 0.8$. This results in $L_L I_L^2 = 2.9$ mH-A² and this is typical for a moderately efficient deflector coil with a 50° tube at 9 kV. The ideal mean valve currents were $i_a = 46.6$ mA and $i_c = 30$ mA but under practical conditions they are both likely to be 5–15 mA greater. This data all refers to the circuit of Fig. 1 which is repeated here for ease of reference.

The voltage and current waveforms are shown in Fig. 4. For the scan period τ_1 they have been calculated from the foregoing data, but for the fly-back period they have been estimated only. The voltage is shown with respect to the "cold" end of the deflector coil, point 1 in Fig. 1. Under the ideal operating conditions, which we are at first considering because they are the simplest, V_2 must be cut off except during the initial part of the scan, when the current is changing from -160 mA to zero. When it is cut off its anode potential must be negative with respect to its cathode, which means that the diode anode potential with respect to point 1 must be more negative than the voltages shown in Fig. 4.

Over the initial part of the scan, however, the anode voltage must vary in a particular way. The required voltage is easily computed if the voltage-current characteristic of the diode is available. From the curves of Fig. 4 take, say, four equal increments of time during the conductive period of the valve and read off the corresponding currents and voltages. From the valve characteristic determine the anode-cathode voltage for each current and add these voltages to those of the circuit, from Fig. 4. Plot the result.

With times of 16, 25.5, 35, 44.2 and 53.2 μ sec, we get currents of -160, -120, -80, -40, and 0 mA and voltages of -89, -91, -93, -95 and -97 V. At these currents the voltage drops across a typical diode are 14, 10.9, 8.2, 5 and 0 V and hence the anode voltage of the diode with respect to point 1 must be -75, -80.1, -84.8, -90 and -97 V.

This curve is plotted as a dotted line in Fig. 4 over the conductive period of V_2 . Outside this region the shape of the curve is unimportant as long as it lies below the voltage curve of the circuit.

This voltage is provided by the device A in conjunction with the $R_1 C_1$ circuit. Generally speaking, $R_1 C_1$ is an auto-bias circuit which under the influence of the mean diode current i_d builds up a constant voltage equal to the back e.m.f. across L_L . Thus

$$i_d R_1 = L_L I_L / \tau_1 = E_L$$

The current of V_1 [Fig. 3(c), Part 1] flows through A

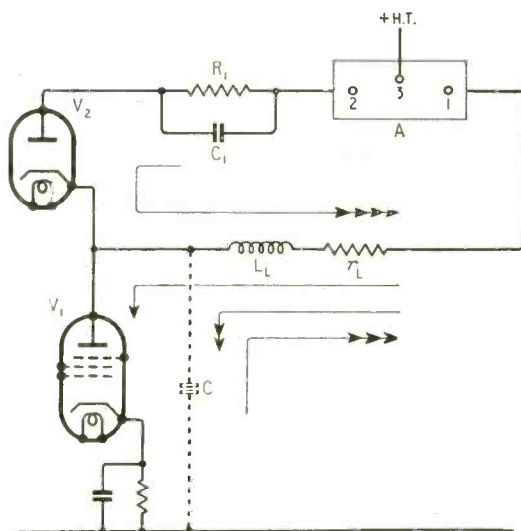
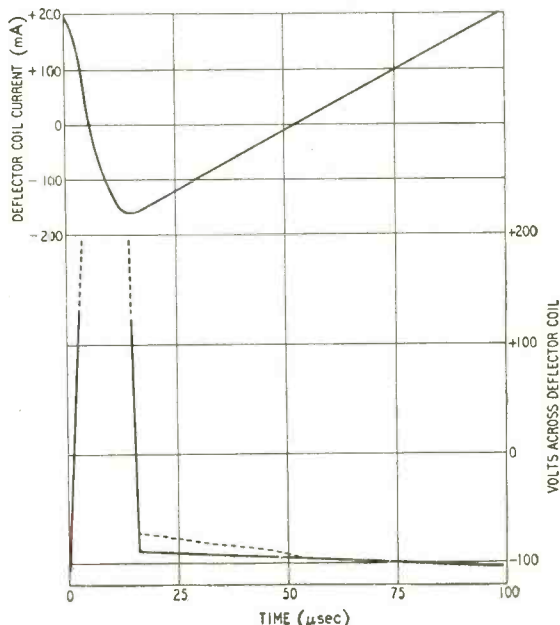

Fig. 1. The basic economy circuit with a directly-fed deflector coil. This diagram is repeated from Part I for easy reference.

Fig. 4. Calculated current and voltage curves for a peak current in V_1 of 200 mA and an overshoot, x , of 0.8. The dotted curve indicates the required anode voltage for the diode during its conductive period. At other times it must be more negative than the coil voltage.



by terminals 1, 3; the current of V_2 [Fig. 3(b)] also flows through it by terminals 1, 2. Under the influence of these currents it must build up the required voltage waveform as just described between terminals 1, 2. It should do this with a minimum voltage drop between terminals 1, 3, since this voltage drop must be taken into account in assessing the h.t. voltage needed.

With the device A in the position shown in Fig. 1 the diode current flows through the whole impedance between 1, 2 and this is usually higher than the impedance between 1, 3 or 2, 3. It is usual to avoid this by a slight re-arrangement of the circuit which becomes as shown in Fig. 5. The current of V_1 still flows through A by terminals 1, 2, but the diode current by terminals 2, 3 while the diode control voltage is developed between 2, 3 instead of 1, 2.

Either circuit will work, but the network forming device A is not quite the same in the two cases. Usually, the position for A shown in Fig. 5 is the better and from now on we shall consider this.

The diode current flowing through the impedance between 2, 3 will set up a voltage drop in opposition to that needed. The voltage developed by the current of V_1 must therefore be sufficient to overcome this. Therefore, in general, the circuit must be of lower impedance between 2, 3 than between 1, 3 and there must be a phase reversal between the two. As a first approximation, therefore, the device A must be a transformer with a step-down turns ratio between 1, 3 and 2, 3.

It must be more than a simple transformer, however, for it has to produce a control voltage for the diode at a time when V_1 is non-conductive. It must, therefore, be of such a nature that it gives a response after the exciting current has ceased.

The device A usually consists of a resonant circuit arranged to act as a tuned transformer and one form is shown in Fig. 6, which is numbered to correspond with Fig. 5. The anode current of V_1 [Fig. 3(c)] flows in at terminal 1 and the diode current of V_2 [Fig. 3(b)] enters at terminal 2. The result is the same as if the wave of Fig. 7(b) flowed in the simple

tuned circuit of Fig. 7(a), this circuit being connected in series with the diode. Two cycles of the wave are shown. The first part of the cycle is the diode current itself and comprises the negative-going step followed by the positive-going linear section. The second part of the cycle—the negative-going linear part ending with the positive-going step—is a copy of the anode current of V_1 reversed in phase by the transformer action and increased in amplitude by the transformer ratio.

The effect of this current wave on the tuned circuit depends on the constants of the tuned circuit. If the damping is critical or greater the circuit is non-oscillatory. The main effect is produced by the steps in the wave at the beginning and end of fly-back and the linear intervening parts have relatively little effect and can be ignored in a first approximation.

The major current step at the end of the scan (A) Fig. 7(b) will produce a voltage wave across the circuit of the general form shown in Fig. 8, curve A. It is a form of saw-tooth and is roughly of the shape required. The second step (B) will produce the same waveform, but inverted and of smaller amplitude, and it will start after the first. The waveform produced by the two steps in succession will be the sum of the two individual waves.

Curve B shows the resultant waveform when the second step occurs at $t/2CR = 0.6$ and curve C when it occurs at $t/2CR = 1$ for the case when the second step has one-quarter of the amplitude of the first. The first, curve B, is more of the form required and leads to such practical values as $0.05 \mu F$ and 13.7 mH with a shunt damping resistor of 262Ω .

Diode Control Waveform

These curves are given only as an indication of the form of the results. Exact calculation is extremely difficult and the writer knows of no way of performing the inverse calculation for determining the required component values. The curves, too, are affected by the position of the damping resistor; it can be in shunt with L and C or in series with either, or it may be split and be partly in series with each.

In practice, it is necessary to determine the proper values by experiment, and it is normal to have the inductance continuously variable as a linearity control. In most final designs the proper damping is obtained by designing the coil to have the proper losses, but sometimes a fixed resistor is used. Instead of the transformer it is quite common to employ a single inductor with two capacitors as in Fig. 9, the step-down ratio being obtained by making the "secondary" capacitor larger than the "primary." This particular arrangement is unsuited to the circuit of Fig. 5 because it interrupts the h.t. supply.

When the conductive periods of the two valves overlap, as they do in practice, the diode current is different from the idealized case just discussed and the anode-voltage waveform required by it is also different. The diode current is greater and the control waveform must be modified to suit.

Simple calculation becomes impracticable because there is no obvious optimum amount of overlap. It becomes necessary to take the curvature of the valve characteristics into account and a graphical method must be adopted. In practice, the simplest course is usually to employ the simple idealized approach to determine suitable values of components for an initial experimental set-up. The precise conditions are then

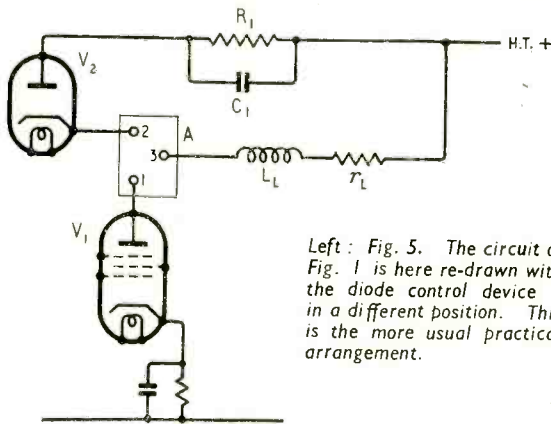

Left: Fig. 5. The circuit of Fig. 1 is here re-drawn with the diode control device A in a different position. This is the more usual practical arrangement.

Right: Fig. 6. One practical form of control element for the diode is shown here. In practice the inductance is variable.

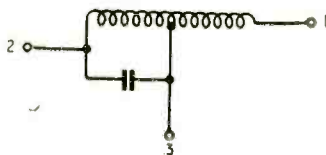

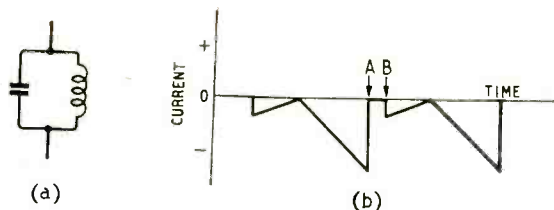

Fig. 7. The control element of Fig. 5 has the same effect as the single tuned circuit (a) fed with the current waveform (b).

found experimentally and consist mainly in finding the proper grid drive and bias for V_1 and the optimum values for the components in A.

This is a case where it is good engineering practice to design by a combination of approximate theory and experiment because it is much less laborious than a full theoretical solution.

The performance obtainable with all circuits of this nature and the values of components required are both very dependent upon the amount of overshoot obtained in the oscillatory fly-back. If the valve V_1 is cut-off very quickly for the fly-back, as it should be, the overshoot is governed by the circuit losses and these occur mainly in the deflector coil. The magnitude of the overshoot is related to the Q of the circuit and, in fact,

$$x = e^{-\pi/2Q}$$

This relation is not of the highest importance at the moment for it is often as easy to measure x as Q , but when the transformer is introduced it becomes necessary.

In order to show the effect of the overshoot the

TABLE 1

x	Q	I_L (mA)	L_L (mH)	C (pF)	i_p (mA)	i_d (mA)	$i_p - i_d$ I_L	E_L (V)	P (W)
0	—	200	72.5	359	84	0	0.42	176	14.8
0.4	1.71	280	37.1	700	60	9.6	0.18	125	7.5
0.6	3.1	320	28.4	915	52.5	18.9	0.1	110	5.8
0.8	7.05	360	22.3	1165	46.6	30	0.0467	96	4.56
1.0	∞	400	18.1	1140	42	42	0	87	3.65

circuit constants have been calculated for several values of x and are listed in Table 1. To those accustomed to work at radio-frequency the Q values will seem remarkably low. In fact, however, a Q of around unity is all that can be expected of a coil wound on a closed core of transformer stampings at some 32 kc/s—the natural frequency of the fly-back. The provision of an air-gap helps considerably and a deflector coil necessarily has a very large air-gap, but even then a Q much in excess of 10 is unlikely. With low-loss materials for the iron circuit much higher Q values are possible.

The figures in Table 1 are all for a valve delivering a peak current of 200 mA and a deflector coil of 2.9 mH-A². They are all for ideal conditions and in practice the mean anode current i_a of the driving valve V_1 is likely to be from 20 per cent to 50 per cent higher. The column headed P shows the product of E_L and i_a ; it is a part only of the total input power because it does not include the anode dissipation of the valves. The point of importance is the way in which it falls as the overshoot is increased. When h.t. boost can be used a part of this energy can be fed back and utilized; the power needed then decreases much more rapidly with increasing overshoot.

The case of $x = 0.8$ is a practical one. If the real anode current is 60 mA instead of the ideal 46.6 mA and the mean anode potential of V_1 is 95 V, the anode dissipation is 5.7 W. The circuit power is $0.06 \times 96 = 5.76$ and so the h.t. input power is about 11.5 W. Although much better than this can be done, it is an arrangement which demands no special materials and is free from many of the spurious oscillation troubles which are liable to occur when a transformer is introduced. With a deflector coil which is far from the most efficient the output is sufficient to scan a normal tube at 9 kV.

Uncontrolled Diode

Before we go on to consider the effect of the transformer it may be as well to say something about a circuit which is quite commonly used and which in its basic form is that of Fig. 1 but with the terminals 1, 2 and 3 of A connected together. In other words, it is the circuit of Fig. 1 without the control device A.

It is quite easy to show that in this arrangement both V_1 and V_2 must be conductive throughout the scan if the current in the deflector coil is to be linear. V_1 has to provide a peak-to-peak current of $I_L(1 + r_L/R)$ where R is the diode resistance; V_2 has to carry the current $I_L r_L/R$ in addition to the current resulting from the overshoot and the voltage developed across $R_1 C_1$ must equal the inductive back e.m.f. across L_L less the initial voltage drop at the start of the scan in r_L and R .

If i_p is the peak current in the deflector coil, the peak current in V_1 is $1 + r_L/R$ times as great and the mean current is $\frac{1}{2} \cdot \frac{\tau_1}{\tau} \left(1 + \frac{r_L}{R}\right) i_p$. The basic efficiency

of the circuit is much lower than with a controlled diode and, unless r_L/R can be made quite small, it may well be poorer than that of the heavily damped circuit.

However, all the surplus current provided by V_1 flows through V_2 into the auto-bias circuit $R_1 C_1$ of this valve. This current is much greater than with the controlled diode and so a greater power is developed in R_1 . When a transformer is used, therefore, there is a

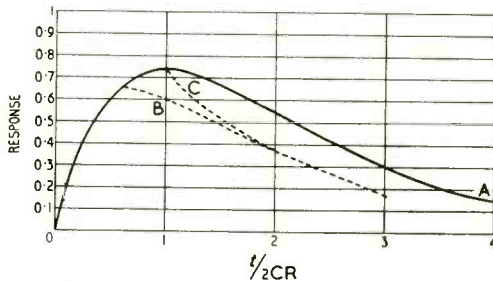

Fig. 8. Response of a critically damped circuit to a sudden change of current is shown by curve A. A second change of current in the opposite direction and of one-quarter the amplitude produces the total result shown by curves B & C for two different intervals between the two changes.

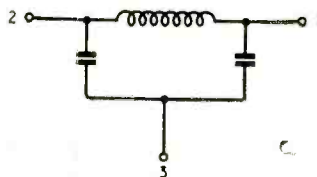

Fig. 9. A common practical form of control network for the diode is shown here. It is inapplicable to the particular circuit of Fig. 1 since it would interrupt the h.t. supply.

greater power available to be fed back as h.t. boost than with the controlled diode and this undoubtedly removes the basic disadvantage of the circuit.

Comparing the two, the controlled diode circuit is very efficient on a current basis and permits a moderate h.t. boost to be obtained. The uncontrolled diode circuit is very inefficient on a current basis, but permits a large h.t. boost. Although basically the less efficient, it may be practically the better circuit in a case where h.t. voltage is the main limitation and plenty of current is available.

In practice, too, it is not necessary to maintain a precisely linear current in the deflector coil. When non-linearity is permitted it is possible to obtain some "current-saving" in the driving valve and the efficiency can be increased appreciably.

So far, we have only considered in detail the directly-fed deflector coil and, as already mentioned, this is very rarely used. A transformer or auto-transformer feed is generally adopted. The next step, therefore, is to consider the effect of this component. Before doing so, however, it is necessary to point out one

practical difficulty that arises with both directly- and auto-transformer-fed coils. With both, the cathode of V_2 is at high potential to earth—up to about 1 kV with direct feed and possibly several kilovolts with an auto-transformer. The heater-cathode insulation of most valves is hardly adequate to withstand this and so the heater must be fed from a well-insulated winding on the mains transformer or, often more conveniently, from a small transformer between the normal heater supply and V_2 .

This is not only a nuisance but it rules out the possibility of d.c. operation of a receiver. It is, therefore, one reason why the use of a double-wound transformer for feeding the deflector coil is so popular. Because there can be a phase reversal between primary and secondary and the diode can be connected to the secondary, the diode cathode can be made earthy. However, diodes rated for heater-cathode peak voltages of as much as 3 kV are making their appearance, and the writer has used metal rectifiers with success. The difficulties of heater supply are thus not at all serious.

(To be continued.)

The Modulation Battle

More Advocacy of A.M. for British Broadcasting

THE long-standing arguments as to the relative merits of amplitude and frequency modulation for British broadcasting were continued at the 4th session of the Brit. I.R.E. Convention, held at Southampton, where J. R. Brinkley (Pye) read a paper entitled "V.H.F. Broadcasting: the case for Amplitude Modulation."

On the question of metre-wave broadcasting in general, the author contended the outstanding merit was its ability to provide multiple programmes, and this advantage should be exploited to the full. Many low-power stations were better than a few of high power, which were inherently inefficient, as attenuation increased rapidly beyond the limits of the optical path.

Mr. Brinkley based his case for a.m. on the twin factors of economics and availability of channels. He

contended that f.m. was inherently more costly; also that for the service he envisaged channels were available on a.m. but not on f.m. To equip the listeners of this country for reception of f.m. would cost about £60 million.

Cheap and satisfactory convertors for f.m. were a virtual impossibility, and the author was highly critical of such units as had already been produced. For amplitude modulation, on the other hand, he claimed the problem could be solved at a cost of about £5, and showed a small 3-valve experimental convertor with crystal control comprising an earth-grid triode as r.f. amplifier, an oscillator-multiplier and a triode mixer. The power requirements of this unit were so small that it could be fed from the supply system of the average receiver. With convertors of this type a.m. broadcasting on metre waves would be compatible

with the existing B.B.C. transmissions, and rapid growth of the metre-wave service might be expected. If the public had to buy completely new receivers, as for f.m., development would be too slow to be effective.

In the discussion that followed, the President of the Brit. I.R.E., Paul Adorian, seemed to express the general feeling by admitting that amplitude modulation had distinct attractions on a short-term basis, especially in view of the present economic situation of the country, but, as a matter of long-term policy and from the engineering aspect, he preferred frequency modulation. Earlier in the session Mr. Adorian had, in his opening address, expressed his belief that the B.B.C. f.m. plan could be justified. It would allow the majority of listeners to use cheap receivers; only those in fringe areas would need expensive sets.

Experimental a.m. converter with three triodes and crystal frequency control.

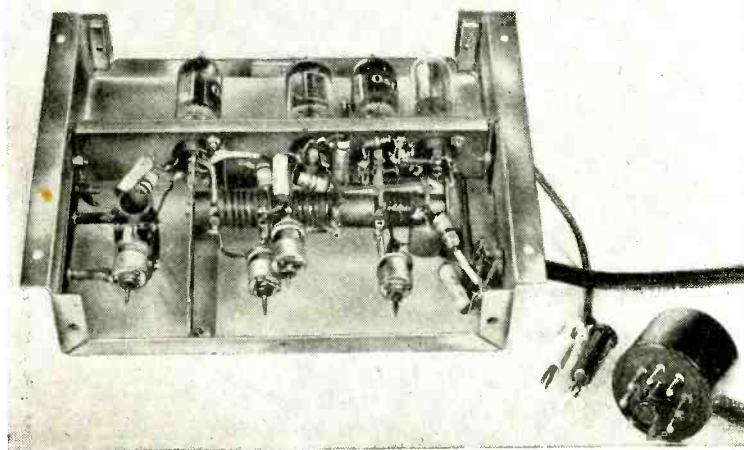

Tens or Twos?

Fingers and Thumbs Don't Count in Electronics

By "CATHODE RAY"

READERS who try to keep up with modern developments, such as electronic calculating machines (or computers) and the newer systems of communication, must surely have come across such terms as a "scale of two" (or some other number) or a "binary scale," and may have wondered what they meant. They may have noticed, too, that some of the best-known radio manufacturers now offer for sale not only such obvious products as receivers and amplifiers, but also mysterious things called "scalers." There are few words even in the English language that have so many meanings as "scale." In this particular context, however, one can hardly suppose that the devices in question are for the processing of fish or crocodiles or even for boiler reconditioning or dentistry. They might conceivably be used in the drawing office, or in the manufacture of measuring instruments, or perhaps be something to do with "scale distortion." But no; this kind of scale is a piece of valve circuitry used in electronic computers and atomic research—among other things. I don't propose to say anything about the circuitry, but will try to explain the rather important basic idea of "scale" itself.

Some time ago I referred to the debt we owe to our system of numerals which we take so much for granted, and how anybody who doubted it should try doing a little simple multiplication in Roman figures. We get so completely used to our system at such an early age that we tend to regard counting in tens almost as a law of nature, and are quite horrified when someone proposes that it would be better to count in twelves and make the sign "100" mean the number we now call 144. Yet there is no reason more binding than widespread custom for making ten the number at which to change from single to double figures, unless it be that most people's fingers and thumbs add up to ten. As the pioneer who invented the dozen probably realized, twelve is a better number than ten on which to base a system, because it is divisible by two, three, four, and six, instead of only two and five.

But that is by the way. The point is that although our familiar decimal (or scale-of-ten) system is used so universally that it has never occurred to most people that there could be any other, we are free to base a system on any number we like. If we adopted the duodecimal or scale-of-twelve system it would be necessary to have two new single figures to stand for ten and eleven, so that the first double figure (10) could mean twelve. On the other hand, a scale of fewer than ten puts some of our present figures out of a job. For the number of the scale is really the number of different values or levels that can be written in single figures. In the scale of ten there are ten: 0, 1, 2, 3, 4, 5, 6, 7, 8, 9. The smallest scale that can be used is two, and it requires only two figures, 0 and 1. All the rest are superfluous.

Although it may be very proper and systematic to expound the nature of a system fully before going on to say how or why it is used, in practice it is very irritating to have to absorb a lot of new information before being able to find out whether it is going to be worth the effort; and in case my rather abstract talk about scales and numerals is engendering a "So what?" attitude among any readers who have not already given up, I had better provide some clue to where all this is leading.

Imagine you are starting to invent an electronic calculating machine. You are using valves so as to get quicker action than is possible with mechanical contrivances. For convenience in reading the answers you connect a milliammeter scaled in whole numbers from 0 to 9 in the anode circuit of the valve dealing with the "units," and similarly for tens, hundreds, etc. The valve is initially biased beyond cut-off, so that the milliammeter reads 0. By means of cunningly devised circuitry you arrange that when the pulses or other signals representing units arrive each one steps up the anode current by 1 mA, and directly 9 mA is exceeded the "units" valve flops back to the start and at the same time sends a signal to the "tens" valve to make it read 1. This is what mileage indicators and other counters do mechanically.

Before long you would probably decide that it might be a waste of time going any further in working out the details of such a system, because it would need a lot of setting up to make all the milliammeters read the whole numbers correctly all over their scales, and it would also be necessary to have all their supply voltages very effectively stabilized, otherwise the readings would go all haywire whenever the electricity people decided to start shedding voltage. And even then one could never be sure that the slope of at least one of the valves had not drifted half a milliamp or more—enough to raise a doubt as to which number was meant.

Twos are Better for Valves

For the really terrific calculations that justify the expense of electronic computing machines it just wouldn't do to have any risk of slipping a whole number here and there, perhaps in the billions column. A valve is all very well, but one is unwise to rely on it to click with mathematical precision and mechanical rigidity into ten different levels on its characteristic curve. The fact that it actually is curved and not straight is another difficulty. And it is taking a risk to expect the triggering action to distinguish infallibly between 9 mA and 10.

It is not, however, asking too much of a valve to expect it to distinguish between "off" and "on." The bias for "no current" can be made as negative as is necessary to ensure such a condition no matter how much the valve characteristics or the voltages are

off-centre; and so long as the current is large enough in the other condition to be recognizable as a current, it doesn't matter (within reason) how much more than the minimum it is. So non-linearity is of no account whatever, nor are drifting voltages or valve characteristics, so long as the valves can still pass any current at all. On this basis the whole thing is as reliable as it possibly can be. ●

And that is where the scale of two, or binary scale, comes in. Since it has only two varieties of figure, 0 and 1, its whole scale is fully represented by the two conditions "off" and "on." And yet the system can count up to any number, the only inconvenience (apart from its unfamiliarity) being the larger number of figures or digits, and hence valves.

Let us see how it works out. *Nought* is, of course, denoted by 0 everywhere. And *one* is denoted by 1. There is no such thing as "2," so adding another *one* means carrying to the next—the "twos"—column, where a 1 appears, and the 1 in the units column is cancelled. This procedure is exactly what we do in the decimal system when adding *one* to *nine*.

Adding another *one* brings 1 back into the units column, so we have "11." (In the decimal system that symbol denotes one *ten* plus one *one*—eleven; in the binary system it denotes one *two* plus one *one*.) Adding the fourth *one* clears the units column again, as the *two* there is carried to the twos column; and as that makes two twos it also is cleared and carried to the next—the "fours" column. Result: 100 (to be read as "one—0—0"). And so on, like this:—

Ordinary or decimal number	Binary scale number
0	0
1	1
2	10
3	11
4	100
5	101
6	110
7	111
8	1000
9	1001
10	1010

By now you will probably have caught on to the thing enough to realize that the next column after the "fours" shows the absence or presence of an eight in the total; the next, a sixteen, and so on. For example: "1001101" in the binary notation would mean $(1 \times 2^6) + (0 \times 2^5) + (0 \times 2^4) + (1 \times 2^3) + (1 \times 2^2) + (0 \times 2^1) + (1 \times 2^0) = (1 \times 64) + (0 \times 32) + (0 \times 16) + (1 \times 8) + (1 \times 4) + (0 \times 2) + (1 \times 1) = 64 + 8 + 4 + 1 = 77$. (Remember that any number to the power 0 is 1.)

Now, you may say, nobody except perhaps a music-hall "lightning calculator" could tell straight off that "1001101" was the number that in the decimal system is called seventy-seven. How can anybody be expected to know without working it out that the seventh figure from the right is a sixty-four, and so on for the others, and that the total comes to seventy-seven? On the decimal system one can see it straight off! Well, admittedly arithmetic in the binary system is less concise, owing to the larger number (though smaller variety) of figures needed; but the duodecimal system certainly wouldn't be open to this criticism, yet people would still complain that it would mean calculation with the twelve-times table to find that "77" meant the number that we call "ninety-one." They would say that with tens it is, of course, quite easy, because they are—well, tens!

Yet really it is just a matter of habit, and if we had

been brought up from infancy to count in twelves or thirteens or threes, with the symbols and names appropriate to the system, it would seem very odd to count in tens. It is really no easier (except as a result of practice) to tell that the number 534 is equal to five hundreds plus three tens plus four than to interpret it as five gross plus three dozens plus four. The difference we make is that we immediately start converting the latter into the decimal number, 760, because we have been accustomed to knowing how many "760" means, and would have difficulty in associating it with the figures "534."

Using Twos for Communication

Though it would be very muddling to introduce the duodecimal or binary or any other non-decimal scale of counting into everyday life, we have seen that the binary system (for example) has distinct advantages for special purposes such as electronic computing. The solution, if the advantages are worth it, is to translate or code the decimal notation into binary for the purposes required, and then back again into decimal when those purposes have been accomplished. After all, this is no more novel than translating the letters of the alphabet into dots and dashes for the purpose of long-distance communication, and then back again.

Originally the morse code was invented because at that time nobody had discovered how to send spoken words by wire in the form of the original sounds, so there was nothing for it but to translate them into signals. But seeing the obvious inconvenience of this indirect method, with its extra process at each end, one might suppose that now line and radio telephony have reached such an advanced state of development code telegraphs would be as obsolete as sending messages by lighting fires on the tops of hills. Nevertheless, the greater part of telecommunication other than domestic radio and telephone is done by telegraphy. Why?

You can appreciate one of the main reasons by considering the output stage in your broadcast receiver. Suppose it is capable of an output of 1 watt without serious distortion from overloading. And suppose you adjust the volume control until the announcer's voice is just reaching this limit at its peaks. Even if he is reading the news in his usual level tones, you might be surprised to know how little the *average* power is. I tried measuring it during sentences of speech (so as not to bring the average down by including the zero power between sentences) and found it to be about one-twelfth of what it would have been if the peak amplitude had been kept up all the time. And, of course, some sounds are reproduced at far less than the average—about one-seventieth in my experiment. I don't claim that these figures are highly accurate—in any case they depend a good deal on the speaker—but they probably represent typical conditions in the transmitter.

That may be all very well for broadcasting, where dozens or even hundreds of kilowatts are used to cover quite moderate distances, and millions of people are contributing all the time to pay for them. But for communication pure and simple the aim is certainty of reception under all conditions, at the minimum cost. The ultimate limiting factor is signal/noise ratio. In telegraphy the sender is either radiating at full power or not at all, and all the receiver has to do is tell which is which. But in telephony one has to provide for handling many times as much power

during the peaks in order to bring the quietest bits well above noise level. They have to be well above, because it is not just a matter of distinguishing between signal and no-signal but between, say, "m" and "n" sounds. Otherwise one is reduced to "m for monkey, n for nuts," etc., and progress is so slow that one might as well use morse and be done with it.

So telegraphy is much more economical and reliable than telephony. But the convenience of being able to speak into a sender and hear the voice come out of the receiver is so obvious that inventors have tried to combine it with the advantages of an on/off signalling system by devising automatic speech coding. The morse code, or any other based on letters and words rather than sounds, makes things very difficult because it necessitates a sort of robot shorthand-typist to translate the sounds of a voice into words; and even a human listener may find that difficult if the speaker comes from another part of the country! So the problem remains unsolved. A more practicable scheme is to make the signalling code mean sounds instead of letters, and this has actually and successfully been done in the Vocoder, which I described briefly some while ago.* The idea behind the Vocoder was not so much the improving of signal/noise ratio as the reduction of the frequency band required by the voice communication channel.

And that is rather a different story. Just now let us stick to the one idea of getting the best possible signal/noise ratio—and hence the longest range for the lowest power—by using simple on/off signals. How can the infinitely graduated amplitudes of speech waveforms, for example, be translated into such simple signals?

If you transmit the waveform of any sound, you can reproduce the sound. For example, if Fig. 1 represented a specimen of a sound waveform you could transmit it by causing the current in a telephone line to have the same waveform. Alternatively (though it would hardly be a practical proposition) you could plot a graph of the waveform on a long strip of paper, make a list of the ordinates (the heights of points on the graph above or below the baseline) at close enough intervals to enable the graph to be replotted at the receiving end, and send them there by telegraph. Taking the first half-cycle of Fig. 1, for example, you would wire the numbers 0, 19, 38, 60, 76, 83, 69, 52, 14, 10, 0, from which the recipient could replot that half cycle; and so on for the rest of the job. The sound could be reproduced from this graph in the same way as the sound track on a film.

This is where we join on to last month's story, which had got to showing how waveforms can be communicated by a series of pulses, sampling the waveform at intervals close enough to include at least two within the shortest wavelength present. In other words, the sampling frequency has to be more than twice the highest frequency to be transmitted. What this sampling amounts to is a particular method of signalling the graph ordinates: they are represented directly by the amplitude of the pulses. To signal the waveform with reasonable accuracy it would probably be necessary to detect amplitude variations down to 1 per cent of the highest peak. So for the smallest pulses to be distinguishable above the noise level it would be necessary for the largest to be 100 times greater in amplitude, or 10,000 times greater in

power, than would be necessary to override noise.

So this method of sampling shares the power-wasting characteristics of the original waveform. Theoretically the numbers could be signalled in morse, but seeing that for tolerable speech quality it would be necessary to send at least 10,000 double-figure numbers per second it might be rather difficult to decode them back again into waveforms! The decoding problem could be simplified if the wave amplitudes were represented by variation in pulse duration. With the 100-unit scale we are assuming that would be equivalent to having anything up to 100 of the shortest pulses side by side (Fig. 2 (b)). If the sampling frequency were 10,000 per second, each sample would have to take place within 1/10,000th sec, or 100μ sec, so the shortest pulse could not at the outside be more than 1 μsec. That would necessitate a bandwidth of over 1 Mc/s right away, for rather poor quality sound, and for only one channel!

But we have already seen that in the binary scale a 7-digit group permits counting in units up to $1+2+4+8+16+32+64=127$, or rather better than the 100-unit scale we have been assuming as a necessity. So any one of 128 different amplitudes (including 0) can be signalled by a group of seven pulses or

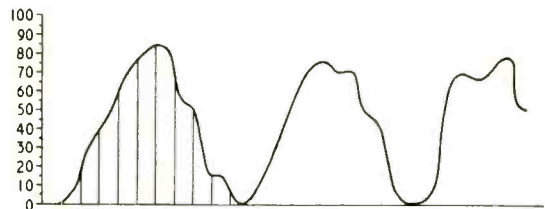

Fig. 1. If sound is transmitted electrically in its own waveform, its peak power must be many times greater than noise and interference, to ensure that the low-amplitude details are not lost.

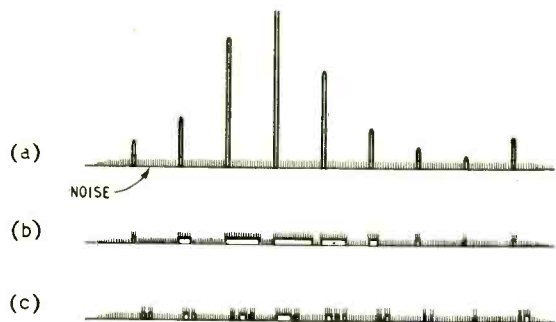

Fig. 2. When the waveform "plots" are signalled by the varying amplitude of pulses (a) it is still necessary to use a comparatively very high power to ensure that the smallest pulses are distinguishable from noise. If, to avoid this, pulse duration is varied (b) the large variations needed demand a very wide frequency band, to transmit the narrowest pulses. But in p.c.m (c) a 128-level range is compressed into a group of only seven equal-sized pulses or spaces.

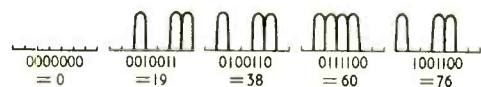

Fig. 3. A close-up of the Fig. 2. (c) type of binary-scale signals, being those necessary to communicate the first five points in the Fig. 1 waveform.

* "Channels of Communication," *Wireless World*, July, 1947.

no-pulses, as in Fig. 3, which represents the first five amplitudes in Fig. 1. Some signals of this type are also shown in Fig. 2(c) for comparison with (a) and (b). A method of decoding has been worked out, and a 12-channel telephone installation demonstrated successfully. • The system, which is called pulse code modulation (p.c.m.) was described in *Wireless World* by Thomas Roddam (March, 1949, p. 82).

What p.c.m. does is to obtain an enormous economy in power for a very moderate price in bandwidth. On the basis of our calculation (which admittedly is oversimplified, but gives the general idea) a sevenfold increase in pulse frequency and therefore of bandwidth allows a 127^2 or sixteen-thousand-fold saving in power. So long as the difference between signal and no-signal can be detected at all through noise and interference, there is no point in using any more power. And whereas frequent relaying of speech, etc., in the usual form causes noise to accumulate at each stage, the p.c.m. signals can be re-formed and cleared of noise and distortion at every stage in a long transmission. But, of course, a system of this kind would not be popular for broadcasting, because the automatic decoding gear would put up the cost of receivers. In a point-to-point system, with only one or two receivers, that is negligible compared with the saving in cost of the sender. Incidentally, there would seem to be nothing to prevent this p.c.m. system being applied to the special low-frequency signals of the Vocodert.

As a matter of interest, let us find the general rela-

† *Journal I.E.E.*, Part III, Sept., 1948, p. 404 (8.2).

tionship between number of digits and number of numbers in a binary group. We have already found that a seven-digit group gives a choice of 128 numbers. That is because the first digit gives a choice of two numbers; for each of them the second digit gives a choice of two, making 2^2 in all; for each of them the third digit gives another choice of two, making 2^3 . And so on; D digits can count 2^D numbers, say N:

$$N = 2^D$$

Another way of writing this is $D = \log_2 N$.

Increasing D from 7 to 8, only about 14 per cent, increases N 100 per cent. And, as we have seen, N is bound up with the signal/noise ratio and minimum transmitter power. So it is very interesting that the Hartley Law ($M = kBT$) in its modern form makes $k = \log_2(R + 1)$, where R is the signal/noise power ratio. It follows that the way in which information is organized for transmission by p.c.m. agrees in principle with the ideal. For example, you can theoretically divide the bandwidth (B) needed to transmit a given amount of information (M) in the seven-pulse groups shown in Fig. 3 by seven, by transmitting it in single pulses (Fig. 2(a)), but the single pulses have to be recognizable at 128 distinct amplitudes, so the signal/noise ratio must be vastly greater. In this way the maximum amount of information that can be communicated by an ideal system depends not only on bandwidth and time but also on signal/noise ratio. But as it is proportional to the logarithm of this ratio, a very large change in signal power is needed to make much difference in the rate of information.

High-Power Klystron

5 kW Output at 500 Mc/s

THE centre-piece in the accompanying illustration is an experimental high-power klystron amplifying valve developed by Varian Associates in collaboration with General Electric of America for use as the output stage in a high-power 500-Mc/s television transmitter. This valve is at present known as the Type Z-1891.

The theory of operation of the klystron is fairly well known, but a brief explanation of this particular valve may be of interest. It has three resonant cavities in cascade through which the electrons pass on their way from cathode to the catcher, or anode. Divergence of the beam is prevented by an external magnetic field.

When an r.f. input signal excites the resonant input cavity the electrons are "bunched," or velocity modulated, so that they travel in concentrations or groups. In passing through the following resonant cavities some power is extracted from these bunches, the operation being such that the power transferred to the output cavity is very much greater than that required to velocity-modulate the beam at the input cavity. Thus the valve behaves as an amplifier capable of very high gain at extremely high frequencies.

As a final broad-band amplifier in a vision transmitter, where the output response is required to be flat to within 1 db over a range of 5 Mc/s, a gain of 50 times is claimed, while in an accompanying sound transmitter, where a relatively narrow band suffices, gains of the order of 5,000 are said to be attainable. Under either condition of operation the output power is said to be 5 kW.

Modulation in the foregoing description means the "bunching" of the electrons; not modulation in the more generally accepted sense by sound or vision signals. This takes place in an earlier stage of the transmitter and the high-power klystron behaves as a linear amplifier.

Pure electron coupling exists in this valve with complete isolation of input and output circuits. The valve is water cooled.

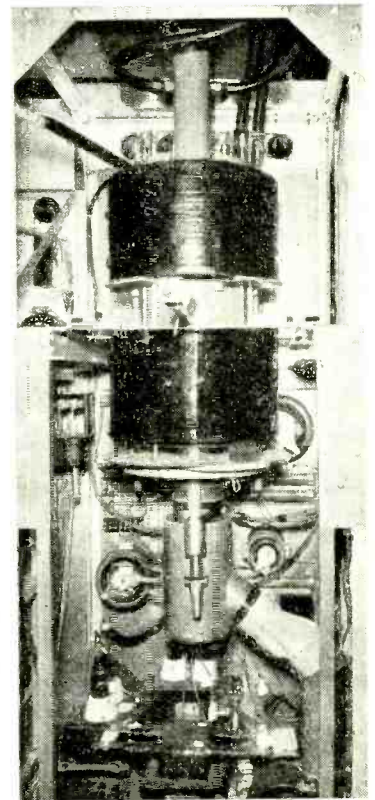

Recording Studio Design

General Principles and Their Application to Small Rooms

By P. A. SHEARS

IN sound recording the studio provides the link between the matter to be recorded and the microphone. It is no less a part of the apparatus than the recording equipment, and equally can make or mar the overall performance; its contribution is therefore worth investigating.

Reproduction of sound over a microphone-loudspeaker system, whether or not recording is interposed, differs from direct listening in several respects. The most apparent of these is that a monaural—single-channel—system combines in the microphone the direct and reflected sound, so the listener cannot exercise his normal faculty of directivity and thus cannot distinguish between sound proceeding directly from the source and that reflected from the walls and objects in the studio. Once the direct and reflected sounds are combined they cannot be separated again; the final quality of the studio output thus depends greatly on the quality of the reflected sound, which appears as reverberation and as an apparent modification of frequency response.

Typical Defects

In practice, moreover, the reflected sound may be emphasized owing to a limited frequency range in the reproducing equipment. Suppose that a studio is bass-heavy due to excessive reverberation at low frequencies; while this defect might not be serious when observed on the relatively wide-range monitor loudspeaker of the recording equipment, when reproduced on an instrument limited to, say, 4 kc/s range, the excessive bass is no longer balanced by high frequencies and a recording may become unrecognisable. Some recording equipments have a bass-cut control which can alleviate this trouble. Frequently, the response of a device is peaked near the limits of its range to give an illusion of greater frequency range; this is done in the case of the ordinary radio loudspeaker and cheapens the whole set. However, if this method is adopted in recording to cover up studio defects, the result may sound quite different on different reproducers; a studio low-frequency resonance may coincide with a loudspeaker resonance on one reproducer and yet be cut off on another. The same applies to variations in high-frequency response. A high-quality loudspeaker in the recording room is of no help, since a response "cooked" to sound balanced over a wide range still is not necessarily balanced over the smaller range of a home reproducer on which a recording might be played.

However, even if the frequency response could be corrected, a bad studio will still introduce a distortion in time. In addition to reverberation prolonging sounds in general, standing waves may be set up in the air or in the structure of the studio which decay relatively slowly. If these or their harmonics coincide or beat with frequencies from the source of sound, a confusion

arises which, for example, makes certain pianos unusable in certain studios. Transients produced at the commencement of a note by the impact of the hammer on the strings may excite modes of oscillation in the room which are reproduced as dull thuds; also, harmonics may become changed in relative amplitude, thus changing the character of the sound.

These defects originate within the studio and can only be remedied in the studio itself. The studio characteristic is three dimensional—amplitude, frequency and time. If the studio is not to upset the balance of high and low frequencies it must clearly

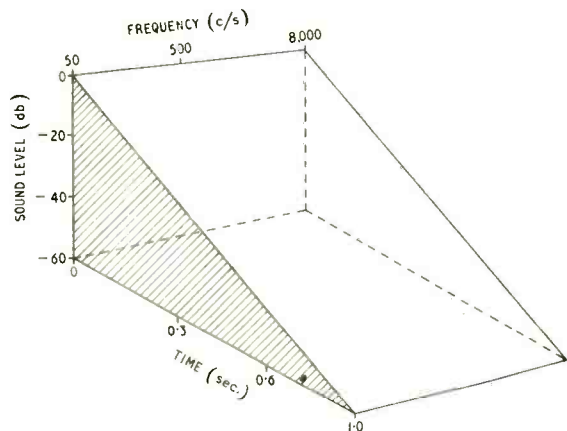

Fig. 1. Idealized reverberation characteristic of a studio.

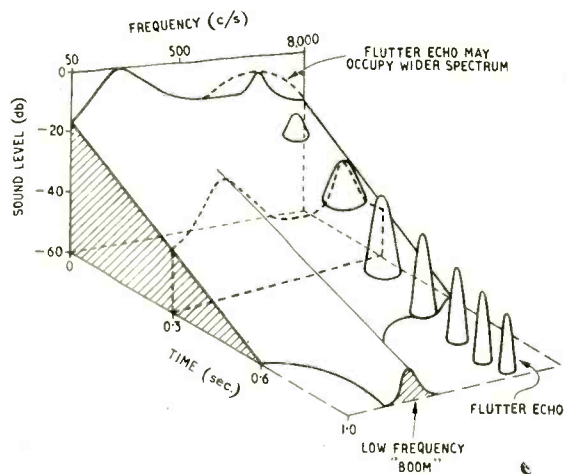

Fig. 2. Reverberation curve illustrating two typical defects in studios.

have a reverberation curve which remains flat throughout the period of decay of a sound. Fig. 1 shows a flat characteristic while Fig. 2 shows a typical pair of defects — an excessive reverberation time at a low frequency and a "flutter echo" due to high-frequency reflections.

The effect of these defects may be reduced somewhat by directional microphones. The ribbon microphone picks up some 6db less reflected sound at low and middle frequencies than the moving-coil type; but the latter also becomes directional to the extent of some 6db, above a few thousand c/s (Fig. 3). However, the fact that the ribbon microphone may

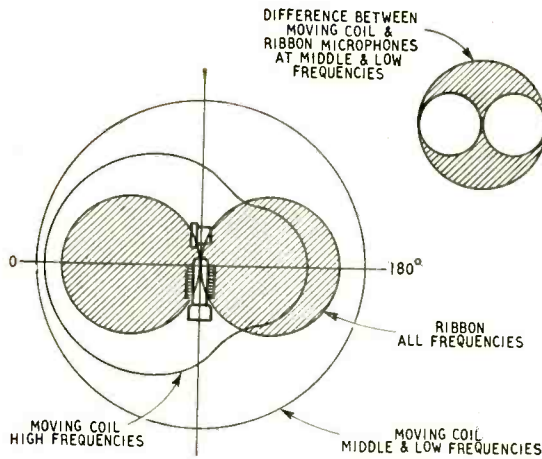
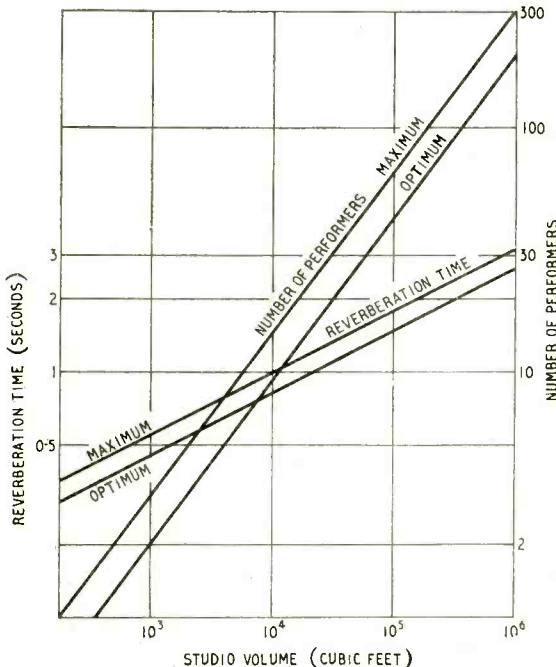

Fig. 3. Illustrating the directivity of ribbon and moving-coil microphones.

Fig. 4. Optimum reverberation time in terms of volume (based on figures given by Kirke and Howe, J.I.E.E. Vol. 78, p.404 1936).



be positioned to avoid picking up from a certain direction, and its better frequency response, have resulted in its more general use.

Reverberation Time

A range of 50-8000 c/s, at any rate on the axis of the loudspeaker, is generally regarded as the minimum for good quality reproduction. The studio should therefore perform satisfactorily over this range, which means in practice (apart from echoes and other anomalies which must in any case be removed) that the reverberation time at any frequency within these limits should not exceed a certain value.

The optimum absolute value of the reverberation time, defined as the time taken for the sound to decay by 60db, depends on the size of the studio and the use to which it is to be put. Fig. 4 has been plotted as the average time for a number of successful concert halls, and extrapolated downwards gives a guide to studio times. Speech generally requires a shorter reverberation time than music; also studios require a shorter time than halls for live performances due to an apparent increase in reverberation time on account of monaural transmission—the ear cannot discriminate against reflected sound; and because the listener's room itself contributes some reverberation. Singers and violinists often prefer a room with a longer reverberation time than the optimum for recording since they can then judge their own tone by listening to the reflected sound. In a large hall this reflection, though too weak to interfere with recording, occurs long enough after the original sound to be audible to the performer. If the reverberation time of a small studio is increased to give a similar effect however, the loudness of the first reflections of sound at the microphone retains the characteristic quality of the sound as that from a small studio. A small studio cannot successfully be made to sound like a large one.

The reverberation time at any given frequency may be adjusted by the amount of sound absorbing material in the room, and may be calculated from Sabine's formula :

$$\text{Reverberation time } T = \frac{0.05 V}{S_1 x_1 + S_2 x_2 \text{ \& etc.}} \text{ seconds}$$

where V is volume of studio in ft^3

$S_1 S_2$, etc., are areas of absorption material in ft^2

$x_1 x_2$, etc., are coefficients of absorption of materials

For coefficients of absorption greater than 0.5 Eyring's version is to be preferred :—

$$T = \frac{0.05 V}{S_1 \log_e (1 - x_1) + S_2 \log_e (1 - x_2) \text{ etc.}}$$

This formula is independent of frequency and suggests that a uniform absorption is required over the frequency range to produce a level reverberation characteristic. However, although the absorption of high frequencies by the air can usually be neglected, at low frequencies standing waves may be set up in the studio, generally referred to as "eigentones." In large studios (10^5 ft^3) the fundamentals of these are of very low frequency but in small studios (3000 ft^3) objectionable modes may lie in the range 50-150 c/s. Their frequencies may be calculated precisely, but a rough guide can be found by regarding one half wave length as occupying the distance between opposite walls, or floor and ceiling. There are thus three fundamental modes corresponding to the length, breadth and height of the studio. These, together with any unpredictable structural resonances which may

occur make it desirable that, rather than have a level reverberation characteristic at low frequencies, these frequencies should be absorbed as much as possible.

The frequency of an eigentone may be calculated from :—

$$f = \frac{c}{2} \left(\frac{p^2}{l_1^2} + \frac{q^2}{l_2^2} + \frac{r^2}{l_3^2} \right)^{\frac{1}{2}}$$

where c = velocity of sound = 1130 feet/sec, p , q and r are integers from 0 upwards, and the fundamental mode in any one direction is given when the corresponding integer (p , q or r) is made unity. For example, the fundamental mode in say the l_1 direction is given then $p = 1$ and q and $r = 0$.

The formula then reduces to :—

$$f = \frac{c}{2l_1}; \text{ or } \frac{1130}{2l_1} \text{ (} l_1 \text{ being in feet).}$$

This mode corresponds to a half-wave lying in the l_1 direction in the studio, with pressure antinodes at the end walls. To find other modes the appropriate values of p , q and r are inserted and a hundred or so alternatives may well arise below 500 c/s.

The crux of the problem of small studios is that these low-order eigentones are within the audible range; for it is these that, because of their large dimensions in relation to the dimensions of the room, are most difficult to absorb or break up.

Provision of Absorption

The curves in Fig. 5 show that the textiles encountered in most living rooms absorb principally high frequencies. These can be used therefore for this purpose in studios, but they are liable to collect and produce dust which may be a nuisance, and professionally, specially made absorbent tiles which can be distempred are often preferred. However, some grades of ordinary insulating board absorb high frequencies to about one-third of the extent of these special absorbers and may suffice where a large enough area can be provided. Also this may be cheaper, if, as is frequently the case, panels of insulating board can be arranged simultaneously to absorb low frequencies by resonance. Resonant absorbers, though practically the only means of absorbing low frequencies, are cheap and simple to construct and may be painted without impairing performance. Basically these consist of a flexible panel mounted several inches from the wall, usually upon battens, thus enclosing an air space in which some absorbent material is provided. If absorption of low frequencies only is required the panel must be sufficiently heavy, and hard enough mechanically to reflect high frequencies; in electrical terms the impedance at the surface of the material must be high enough to reflect high-frequency sounds. At low

frequencies the panel must be flexible enough—i.e., of low enough mechanical impedance—to vibrate over an adequate area to couple the absorbent in the air space to the air in the studio. Part of the energy is dissipated here, and part in the internal damping of the panel material itself. The electrical analogy is a damped acceptor circuit, and the construction is shown in Fig. 6.

The panel may be of various materials from paper to building board, or insulation board, and rock wool may be used around the perimeter of the air space to provide damping. In the case of a panel of thick

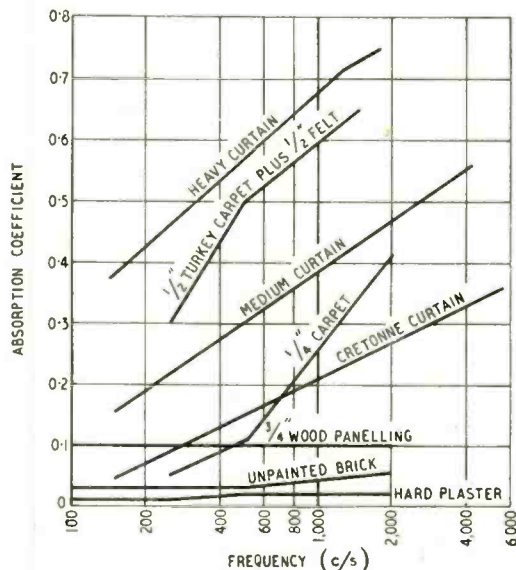
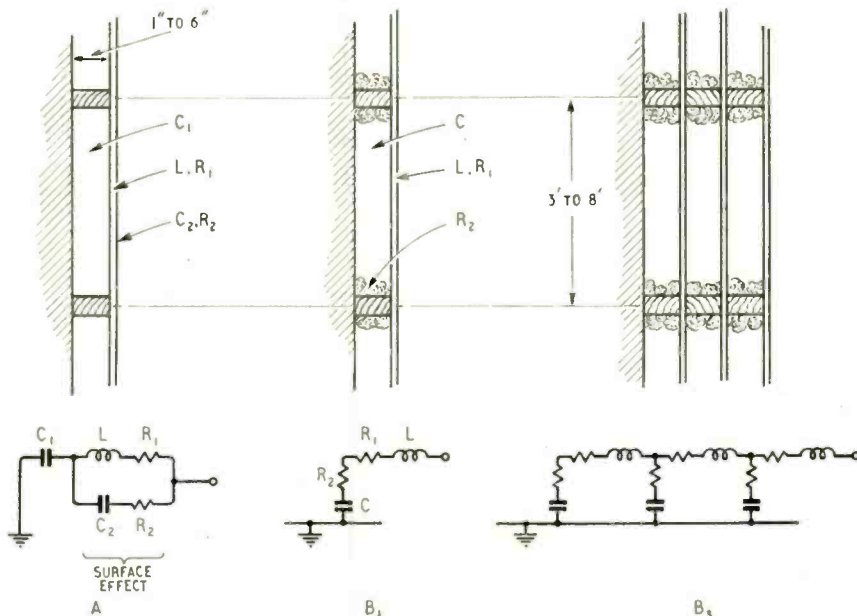

Fig. 5. Absorption coefficients of some typical materials (based on data from reference 5).

Fig. 6. Absorbent panels and their electrical equivalent circuits.



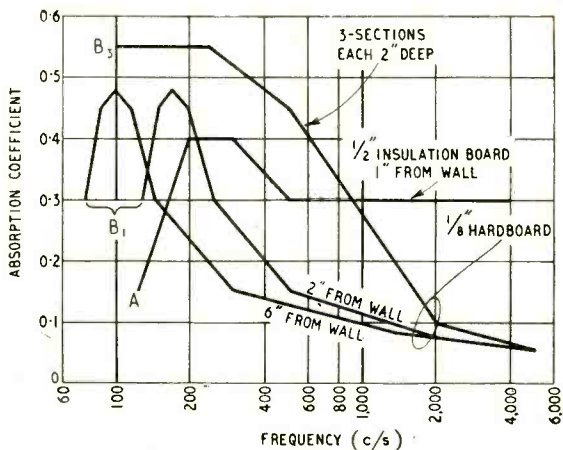
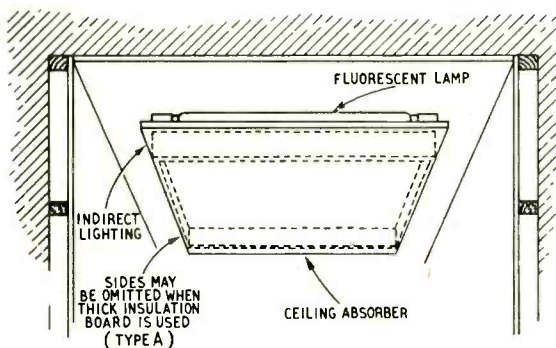
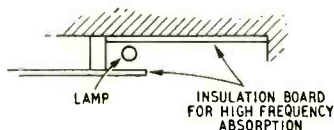

Fig. 7. Characteristics of some resonant absorbers (based on data from reference 5).

Below : Fig. 8. Ceiling absorption unit.



soft material this latter may be unnecessary owing to high internal damping in the panel.

Curves for typical absorbers are shown in Fig. 7. A is a curve obtainable with a $\frac{1}{2}$ in thick soft insulating board ; B₁ a curve for an $\frac{1}{8}$ in thick hard board ; and B₃ a 3-layer absorber of the same board as B₁ analogous to a 3-section filter incorrectly terminated. The difference in high-frequency absorption of the two materials is clear. The choice of panel material usually depends on the amount of high-frequency absorption required, the mounting and spacing from the wall controlling the low-frequency absorption.

The spacing from the wall is given by :—

$$d = \frac{29,900}{f^2 w}$$

when

d = distance of panel from wall in inches

w = weight of panel in lb/ft²

f = frequency of maximum absorption

Fixing centres of the battens must not be too close, otherwise the vibration of the panel will be interfered with, reducing the absorption coefficient at the resonant frequency. The centres should be varied

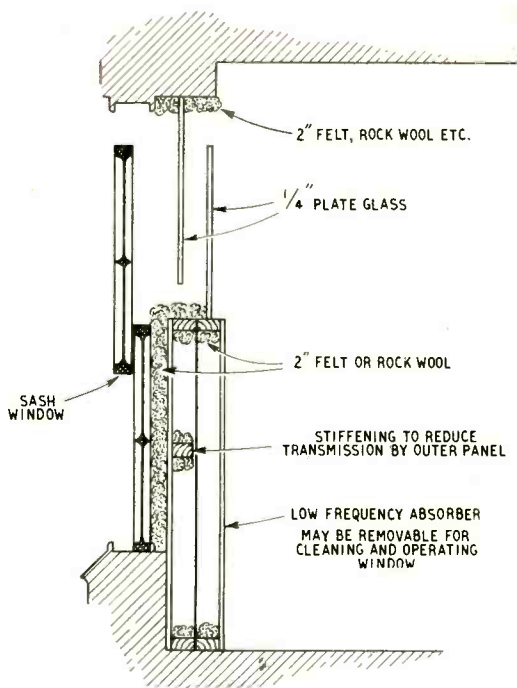

Fig. 9. Window treatment to admit light and air combined with low-frequency absorber. Sound insulation is about 40db closed and 25db open.

somewhat throughout the studio—3 to 8 feet is a suitable range.

In medium-sized studios such as that in the example in Fig. 10 the eigentone fundamental frequencies may be below 50 c/s, for which inconveniently large absorbers would be required. However, provided that the response of the recording equipment falls off fairly sharply outside the working frequency range these very low frequencies may be ignored. In magnetic recording the problem seems less important, but the author experienced one case in disc recording where a guitar band so strongly excited an eigentone of about 25 c/s that the resultant patterning of the disc prevented satisfactory playback.

Normally, the resonant panelling may be tuned to the lowest eigentone frequencies in the working range. The spacing from the wall will depend on the grade of board used and may be calculated from the formula given above, and will usually be between 1 and 6 inches depending on the frequencies to be absorbed.

Distribution of Absorption Material

In most cases of small studios it will be found necessary to cover the greater part of the interior surface of the studio with treatment. This is especially so when converting ordinary rooms to studios, since studios constructed as such generally have thin floors specifically for absorbing low frequencies. If the floor is concrete or heavy board some treatment must be applied to the ceiling.

This follows the general rule that absorbers are not effective for directions of propagation parallel to their surface. A floor-ceiling mode of resonance is scarcely affected by material on the walls. This

means that at any rate three surfaces, one in each plane, must be treated; and as absorption is only about 30 per cent it is desirable that all surfaces should carry some treatment.

It will usually be found that some of the low-frequency absorbers must reflect high frequencies if the high-frequency reverberation time is not to be reduced excessively. If this panelling is located on the lower half of the walls, furniture will help to disperse direct reflections between opposite sides. At a higher level—say about 4ft from the floor, hard reflecting surfaces should not face one another.

If these hard surfaces are grouped principally near one end of the studio—the “live” end—while curtains are provided at the other “dead” end, a useful variation in effects can be produced. Usually, however, the performers will occupy the live end and the microphone a position towards the dead end. If the floor is carpeted this should be arranged to roll back from the live end, but the ceiling above must carry some absorbent (Fig. 8).

Various sound insulating schemes will be found in textbooks to permit windows to be opened without admitting noise. Fig. 9 shows the type of arrangement. For the purpose of calculation the noise in the studio should not exceed 20 phons. The recording equipment must be in a separate room for monitoring and to avoid distracting performers, and a double window between may be found necessary to avoid acoustic feedback. A threshold condition of “singing” must be avoided at all costs as this modifies the frequency response. It is worth remembering that the least crack around a door or window transmits a considerable amount of sound and any insulating door or window must be made literally air-tight, with rubber or felt.

An Example

A room 20ft × 15ft × 12ft high with hard plastered walls and coconut matting over floorboards is to be converted to a studio.

1. Volume = 3600 ft³
From Fig. 4 reverberation time not to exceed 0.7 sec.

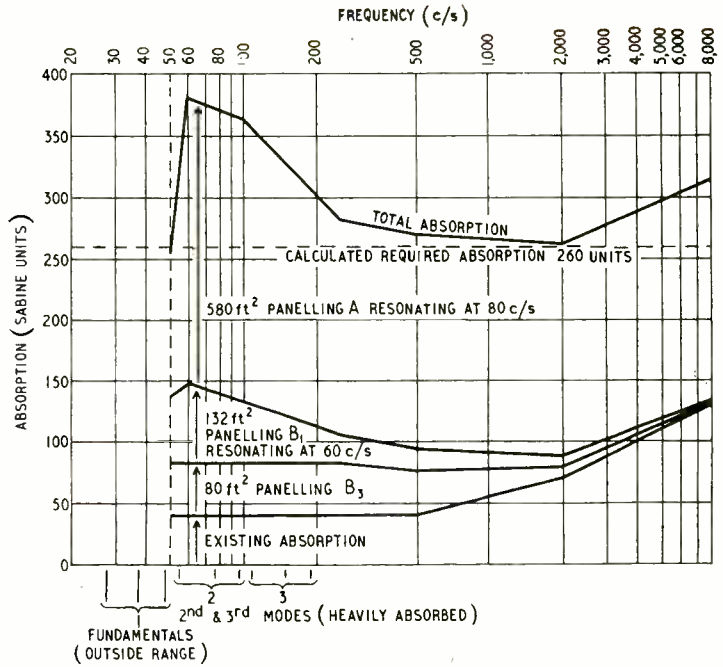

Above: Fig. 10. Absorption and reverberation calculations for the studio (Fig. 12) considered in the example.

Right: Fig. 11. Calculated reverberation frequency curve (1) from data of Fig. 10, (2) with alternative treatment of 660ft² of insulation board on 2-in battens.

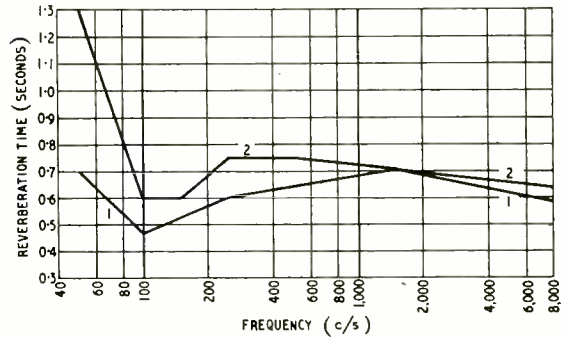
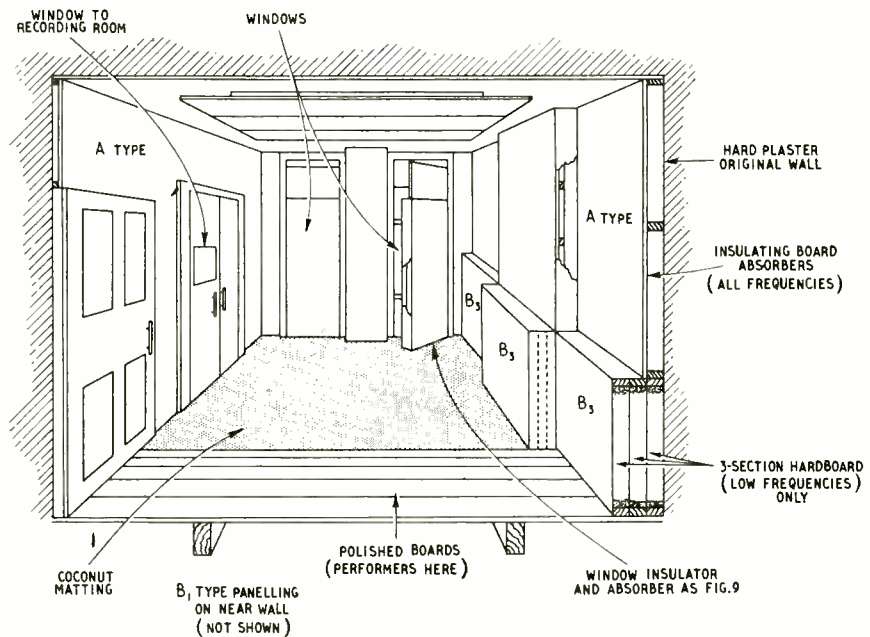

Fig. 12. Suggested layout of room 20ft × 15ft × 12ft treated according to calculations in the text.



2. From $T = \frac{0.05 V}{S_x}$, $S_x = 260$ Sabine units

3. Calculate first eigentones :

$f = \frac{1130 \text{ c/s}}{2l}$, where l = length, width, height in feet respectively

TABLE
Absorption in Sabine Units.

Frequency (c/s)		50	60	100	250	500	2000	8000
Floor (300ft ²)	{ Coefficient ...	0.1	0.1	0.1	0.1	0.1	0.2	0.4
	{ Absorption ...	30	30	30	30	30	60	120
Doors (100ft ²)	{ Coefficient ...	0.1	0.1	0.1	0.1	0.1	0.1	0.1
	{ Absorption ...	10	10	10	10	10	10	10
Existing absorption (P) ...		40	40	40	40	40	70	130
Type B ₃ panelling (80ft ²)	{ Coefficient ...	0.55	0.55	0.55	0.55	0.45	0.1	0.05
	{ Absorption (Q) ...	44	44	44	44	36	8	4
Type B ₁ panelling (132ft ²)	{ Coeff. when resonating at 60 c/s	0.39	0.48	0.36	0.17	0.14	0.08	0.05
	{ Absorption (R) ...	52	63	48	22	19	10	5
Type A Insulation board (580ft ²)	{ Coeff. when resonating at 80 c/s	0.2	0.4	0.4	0.3	0.3	0.3	0.3
	{ Absorption (S) ...	116	232	232	174	174	174	174
Total absorption (P+Q+R+S) ...		252	379	364	280	269	262	313

4. Calculate absorption : (see Table above)

(1) Existing absorption.

Floor : $15 \times 20 = 300\text{ft}^2$

Absorption coefficient—below 200 c/s as for $\frac{3}{4}$ -in panelling (0.1), above 500 c/s estimated absorption of coconut matting half that of $\frac{1}{4}$ -in carpet (see Fig. 5).

Doors : 100ft^2 . Absorption coefficient 0.1.

(2) 3-section absorbers for a band of low frequencies. As these are bulky they must be

fitted into the room structure as convenient, and their area is thus predetermined, e.g., 80ft^2 , coefficient of absorption as Fig. 7.

(3) Panelling to absorb low frequencies only—Type B₁. The amount of this is chosen so that total absorptions at low and high frequencies are as nearly as possible equal. 132ft^2 was found to be a convenient area in the example.

(4) The remainder of the absorption is provided by insulation board which to some extent absorbs all frequencies, the low-frequency resonance being adjusted to absorb the respective eigentone of the wall concerned. This resonance is fairly broad and a uniform spacing from the various walls will often suffice and save cost (see Fig. 7).

(5) Plot total absorption and check final reverberation time.

Figs. 10 and 12 show the absorption provided in a fully treated studio. Fig. 11 shows (curve 2) the

rise in bass reverberation time resulting from the use of a cheaper arrangement of panelling—which does not fully absorb the low frequencies. Curve 1 corresponds to Fig. 10.

References.

1. Meyer, "Electroacoustics" (Bell).
2. Wood, "Acoustics" (Blackie).
3. Hope-Bagenal, "Practical Acoustics" (Methuen).
4. Cullum, "The Practical Application of Acoustic Principles" (Spon).
5. Constable and Constable, "Principles and Practice of Sound Insulation" (Pitman).
6. Moir, "Acoustics of Small Rooms," *Wireless World*, Dec. 1944.

NEW BOOK

The Testing of Hearing Aids (Booklet No. 490), by D. B. Fry and P. Denes. Pp. 39 with 11 illustrations. The National Institute for the Deaf, 105, Gower Street, London, W.C.1. Price 1s.

THE task of evaluating the performance of a hearing aid in general terms and on the basis of objective measurements is a formidable one. In view of the wide diversity of hearing defects and the range of age and aptitude in patients, one might be justified in thinking the difficulties insuperable. However, by limiting the problem to the transmission of intelligible speech and by carrying out large numbers of tests under carefully controlled conditions, workers both in this country and America have arrived at an optimum performance specification which appears to be independent of the particular type of deafness involved and which serves as a satisfactory basis for correlating subjective judgment with objective measurement.

In this book the authors give a well-reasoned argument, supported by references to the work of the Medical Research Council, the Harvard University report on hearing aids and others, for the validity of objective testing and describe in detail the apparatus used for the measurements upon which the National Institute for the Deaf will issue test reports on commercial hearing aids.

One assumes that the object of issuing this booklet is to inspire confidence in the reliability of these reports. By placing all their cards on the table and by showing

that those responsible for devising the tests have a rational and practical appreciation of the problem, they have not only succeeded well, but have also provided students of electro-acoustics with a well-written resumé of recent advances in the theory of hearing aids. F. L. D.

I.F. After Copenhagen

WHEN the B.B.C. moved on to its new Copenhagen Plan frequencies last year, unexpected whistles came into the homes of millions of listeners who were using superhet receivers. The reason was, of course, that the most commonly used i.f., 465 kc/s, was no longer suitable for the new frequencies and all kinds of heterodyne notes were being generated. This eventuality, predicted some time before the change*, has now been confirmed by the Broadcast Receiver I.F. Sub-Committee of B.R.E.M.A. in a report on a series of tests carried out by various B.R.E.M.A. member firms. Three i.f.s were under consideration, 422 kc/s, 465 kc/s and 470 kc/s, and the tests covered a total of 31 different sites. The main conclusions of the report are that 465 kc/s is, in fact, no longer satisfactory as a standard i.f. and that set manufacturers should confine their choice to either 422 kc/s or 470 kc/s. There is absolutely no hope of finding a single i.f. that will give freedom from whistles on all B.B.C. stations in all parts of the country.

* *Wireless World*, September, 1949, page 322.

18TH National Radio Exhibition



Classified Guide to the Principal Classes of Exhibits

Place: Earls Court, London, S.W.5
Date: 29th August to 8th September
Times: 11 a.m. to 10 p.m.
Admission: Adults 2s. 6d., Children 1s.

method of presentation gives a comprehensive view of the activities of the various exhibitors, and also enables the makers of any particular class of equipment, and their stand numbers, to be located quickly and easily. Those who are unable to visit the exhibition and depend on the pages of *Wireless World* will, it is believed, find this form of presentation a useful reference.

Lists of exhibitors are given both numerically by stand number and alphabetically under trade names or abridged company names.

Perhaps it need hardly be said that this year television will again be the centre of attraction. This is partly due to the imminent opening of the northern station, Holme Moss, which will bring a further 12 million people within the range of a station, and of the Scottish station at Kirk O'Shotts, and in part to a number of technical developments. In the 250-foot television viewing avenue, some 40 makes of receiver will be working.

THE Eighteenth National Radio Exhibition, organized by the Radio Industry Council and supported by 88 manufacturers and a number of non-commercial users of radio—such as the Armed Forces—will be opened by Earl Mountbatten at Earls Court, at 11.0, on August 29th. On the preceding day a pre-view of the exhibition has been arranged for overseas visitors and specially invited guests.

We have again prepared our guide to the exhibition in a classified and tabulated form as we believe this

(1) Murphy V202C with 12-in tube. (2) Kolster-Brandes receiver with rectangular c.r. tube. (3) Stella ST1480U console. (4) H.M.V. type 1815 table model. (5) Peto Scott TV169 projection receiver.

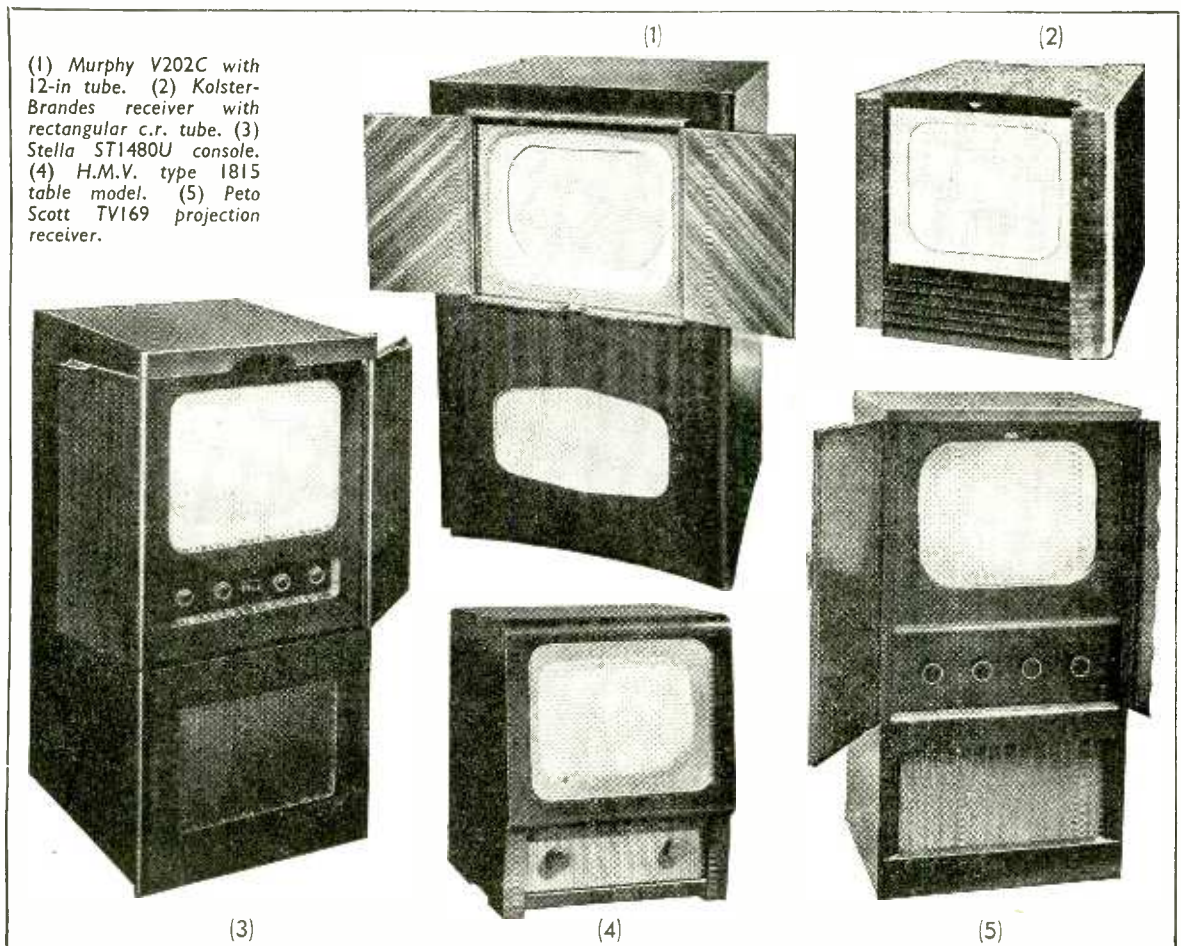

Larger and brighter pictures are the dominant feature of the new season's models and few sets have a c.r. tube smaller than 12in, while several makers are showing sets fitted with 15- or 16-in tubes. The introduction into television sets of the "flat-face" type of tube will, it is claimed, provide a wider viewing angle and produce the effect of a larger tube.

The present indications are that few changes, apart from cabinet designs, will be found in sound broadcast receivers. Portables and personal portables are becoming more popular and incidentally smaller.

In the field of sound reproduction the principal highlight is a more general use of two- and three-speed turntables in radio-grams and record players.

The tendency towards specialization in radio exhibitions is more than ever noticeable this year. It will be very apparent to the visitor that the national show is largely one of domestic radio equipment. A few component makers whose products are available on the retail market are showing, but the specialized firms catering for set makers only are far less prominent.

Rather surprisingly, fewer firms than had been expected are showing test apparatus and anything in the nature of fixed and mobile communications equipment is virtually non-existent, the special exhibits of the three Services excepted.

Our classified lists do not include the non-commer-

cial exhibits of the Government Departments, Forces, B.B.C., D.S.I.R., etc., and we must therefore deal with them briefly in this introduction. The B.B.C.'s participation is largely centred in the television studio in which programmes are to be rehearsed and broadcast. On their stand they invite visitors to "come and be televised"; for this they are using two 12-inch monitors. A 1:7 working model of one of the feeder switching towers at the B.B.C.'s short-wave station is demonstrated on the stand.

Each of the three Services has a stand. To deal with the senior service first; the Royal Navy's exhibit represents the bridge of a modern cruiser and the operations centre in which is simulated the action taken during an aerial attack on the ship. In addition to this live display the stand also exhibits the type of equipment issued by the Admiralty to members of the Royal Naval Volunteer Wireless Reserve for training in their own homes.

Both the Royal Corps of Signals and the Corps of Royal Electrical and Mechanical Engineers—the main users and the repairers of Army communication equipment—jointly man the War Office stand which depicts signalling systems through the ages and the equipment necessary for the maintenance of modern radio and radar gear.

The Royal Air Force exhibit consists mainly of
(Continued on page 364)

ALPHABETICAL LIST OF EXHIBITORS AND GUIDE TO THE STANDS

Name	Stand	Name	Stand	Name	Stand
A.R.B.M.	67	English Electric	58	Ossicaide	32
Ace	41	Etronic (Hale)	92	Peto Scott	73
Aerialite	47	Ever Ready	49	Petter	103T
Alba (Balcombe)	89	Ferguson	77	Philco	54
Ambassador (Fitton)	4	Ferranti	74	Phillips	83, 90
Amplion	114	G.E.C.	28, 51	Pilot	66
Antiference	94	G.P.O.	233	Plessey	8
Army	234	Gamma	15	Plus-a-Gram (Margolin)	25
Avimo	10	Garrard	68	Portogram	115
Avo (Automatic Coil Winder)	9	Goldring (Scharf)	35	"Practical Wireless"	30
B.B.C.	237	Goodmans	96	Pye	17, 65
Baird (Scophony)	50	Gramplan	110	R.A.F.	232
Barclays Bank	20	H.M.V.	84	R.G.D.	76
Belclere (Bell & Croyden)	22	Haynes	6	Regentone	88
Belling-Lee	64	Hobday	101T	Roberts	44
Bernards	104T	Hogg	106T	Rola-Celestion	39
Board of Trade	1	Hunt	95	S.T.C.	87
"British Radio & Television"	24	Imhof	93	Scott	18
British Railways	70	Invicta	78	Simon	13
Brown Brothers	107T	J.B. Cabinets	33	Skarsten	19
Bulgin	2	K.B.	52	Sobell	56
Burndept	40	Kerry's	102T	Stella	111
Bush	62	L. & P. Factors	105T	T.C.C.	97
Collaro	81	L.E.S.	109T	Taylor	38
Columbia	46	Lloyds Bank	42	Telerection	27
Connoisseur (Sugden)	12	M.C.A.	236	Television Society	36
Cossor	86	Magnavista (Metro Pex)	31	Trix	23
D.S.I.R.	235	Marconiphone	79	Ultra	53
Decca	82	Masteradio	80	Valradio	21
Defiant (Co-op)	91	McMichael	59	Vidor	55
Dibben	108T	Mullard	75	W.B. (Whiteley)	60
Dubiller	45	Multicore	48	Waveforms	34
Dynatron	71	Murphy	61	Wearite (Wright & Weaire)	112
E.M.I.	85	Nationa Provincial Bank	26	Westinghouse	43
Econasign	11	Navy	231	Westminster Bank	72
Eddystone (Stratton)	7	Newman	29	Winel (Elwin)	14
Ediswan	63			Winrad (Winter Trading)	99T
Eelex (Eastick)	100T			"Wireless & Electrical Trader"	3
Ekco	57			"Wireless World"	98
"Electrical & Radio Trading"	113			Wolsey	5
Electron (New London)	44A				
"Electronic Engineering"	37				
Elpico (Lee)	16				

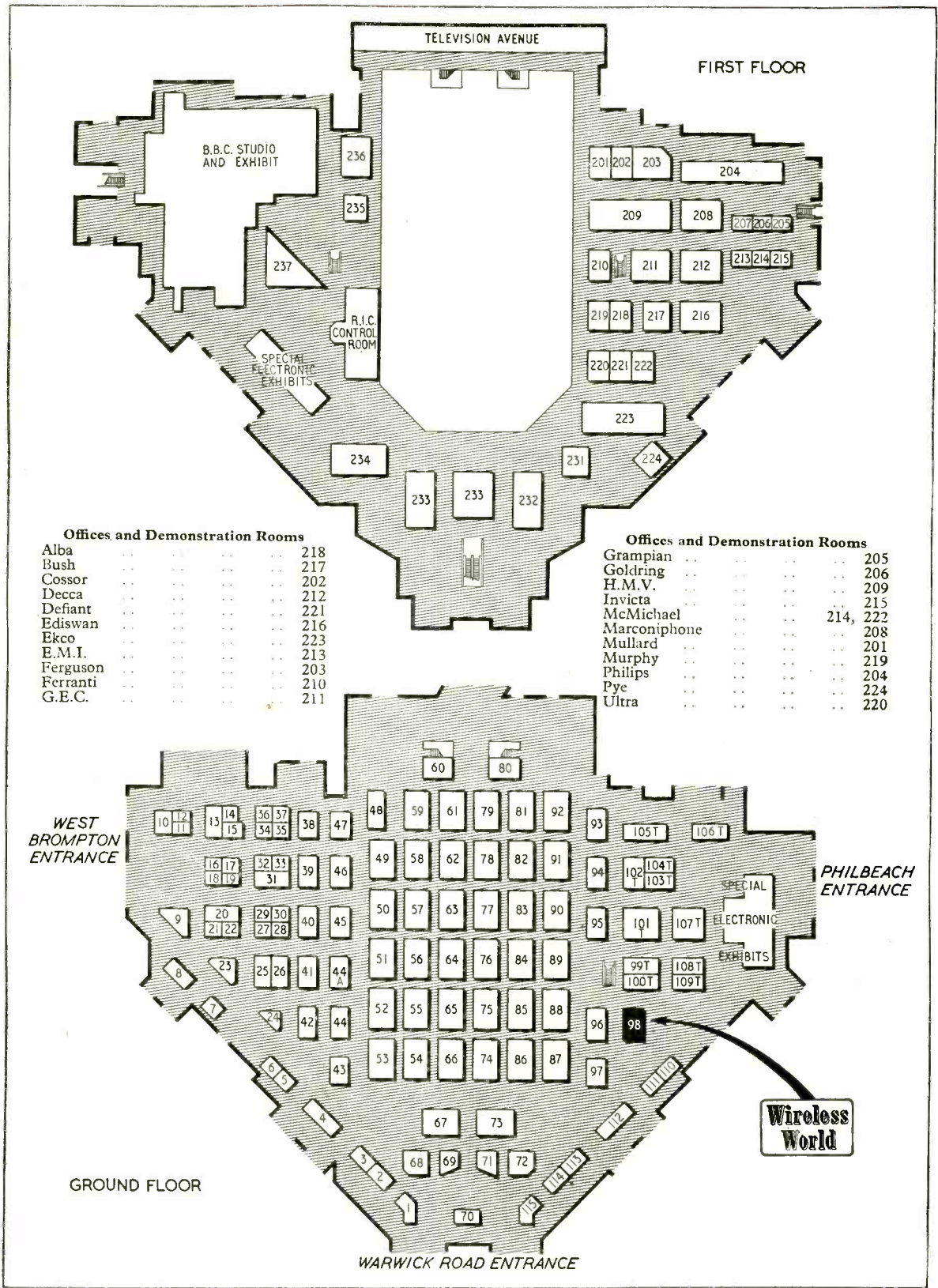

Offices and Demonstration Rooms

Alba	218
Bush	217
Cossor	202
Decca	212
Defiant	221
Ediswan	216
Ekco	223
E.M.I.	213
Ferguson	203
Ferranti	210
G.E.C.	211

Offices and Demonstration Rooms

Grampian	205
Goldring	206
H.M.V.	209
Invicta	215
McMichael	214, 222
Marconiphone	208
Mullard	201
Murphy	219
Philips	204
Pye	224
Ultra	220

five pieces of radio and radar equipment, including a trainer (Type 102) which simulates the responses received in aircraft fitted with H2S blind bombing apparatus. Air interception gear, Rebecca, Gee and the transmitter-receiver TR1936 which is now standard communication equipment for bombers in the R.A.F.

The activities of the Post Office in the fields of radio and telecommunications generally, and the contributions made by its research engineers to improve the public services are illustrated on the two large stands occupied by the G.P.O.

The main feature of the Ministry of Civil Aviation exhibit is a scale model of London Airport as it will ultimately be, showing the radio and radar aids at present in use.

All the non-commercial users of radio so far mentioned make use of the ionospheric recordings of the Radio Research Directorate of the D.S.I.R. On the Department's stand a recorder, which continuously sounds the ionosphere with pulses in the frequency band 0.6 to 25 Mc/s is demonstrated. Variations in the service area of a television station due to meteorological variations is also illustrated. By using two television receivers on the stand, one tuned to Alexandra Palace and the other to Sutton Coldfield, it is hoped to demonstrate the varying signal strength from the latter (but not A.P.) during weather changes.

In conclusion, we will touch upon the technical services provided at the show for the distribution of sound and vision. Television will be distributed to the stands on the Sutton Coldfield carrier frequencies to avoid interference with the reception of the

Alexandra Palace transmissions. Three sources of programme will be available: (a) B.B.C. transmissions, for the reception of which a radio link working on 6,800 Mc/s will be used between Alexandra Palace and the exhibition; (b) films from a film scanner in the control room in the exhibition; and (c) programmes from the B.B.C. studio in the Hall. A small transmitter, installed in the exhibition control room, feeds the distribution amplifiers. The distributed signal, which has an average level of $1\text{mV} \pm 3\text{db}$ measured on Test Card "C," conforms in every way to standard B.B.C. practice.

A radio-frequency distribution system working on $1030\text{kc/s} \pm 150\text{c/s}$ is fed by co-axial cable to a number of demonstration rooms on the first floor of the exhibition for the operation of broadcast receivers. This signal will be modulated by magnetic-tape recordings. The signal level at each outlet is 300mV and the frequency response is within $\pm 2\text{db}$ from 20c/s to 14kc/s .

A second service, for the demonstration of audio equipment, is superimposed on the cables carrying the medium-wave r.f. signal. The overall frequency response from the Post Office line input to the a.f. outlet on the stands is within $\pm 3\text{db}$ from 20c/s to 16kc/s . There is, of course, the usual sound reproducing system for music and announcements throughout the show and a subsidiary amplification system for relaying the sound from the B.B.C. studio to the visitors looking through the glass-panelled walls.

The focal point of the technical services at the show is the R.I.C. glass-panelled control room situated on the first floor.

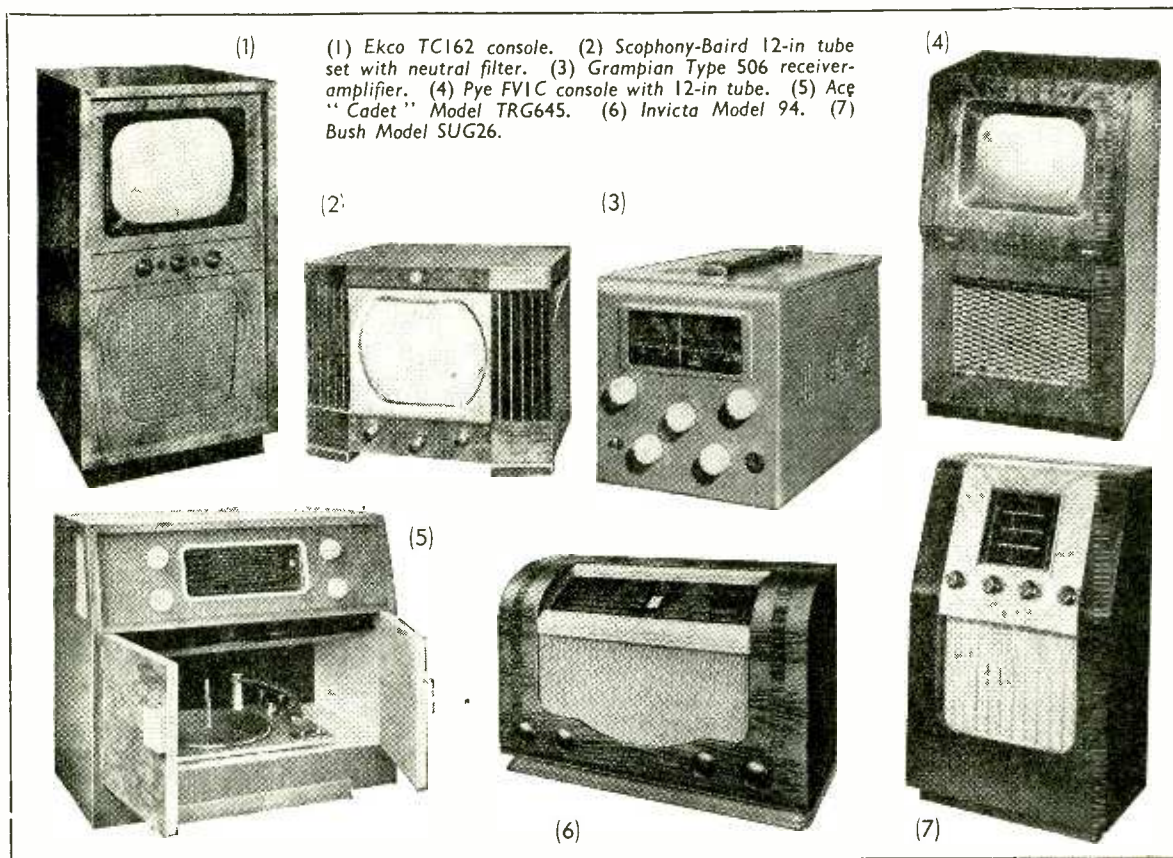

(1) Ekco TC162 console. (2) Scophony-Baird 12-in tube set with neutral filter. (3) Gramplan Type 506 receiver-amplifier. (4) Pye FV1C console with 12-in tube. (5) Ace "Cadet" Model TRG645. (6) Invicta Model 94. (7) Bush Model SUG26.

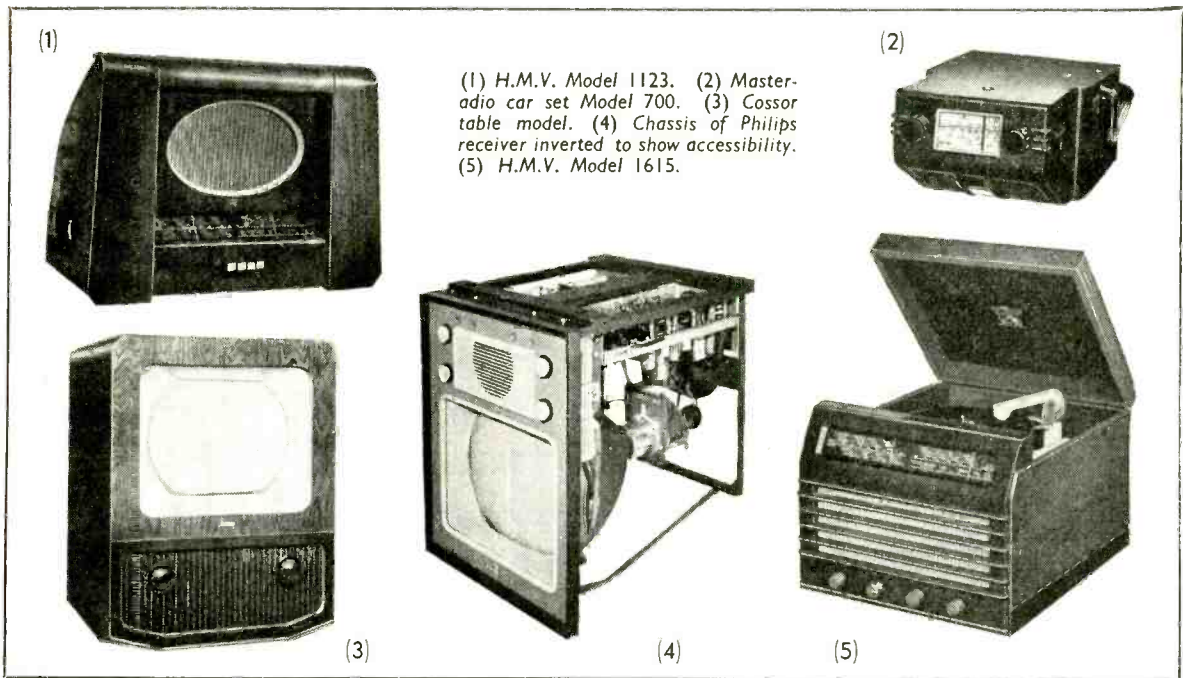

(1) H.M.V. Model 1123. (2) Masteradio car set Model 700. (3) Cossor table model. (4) Chassis of Philips receiver inverted to show accessibility. (5) H.M.V. Model 1615.

RECEIVERS : Broadcast, Television, Communications and Special Purpose

FIRM	(Stand)	Broadcast							Television				V.H.F.	Communications	Schools	Trawler-band	Car		
		Mains	Battery	Mains/battery	Portable	Personal portable	Radio-gramophone	Chassis	Kits	Direct-viewing	Projection	Television-broadcast						Chassis	Kits
Ace	(41)	•	•	•	•	•	•	•	•	•	•	•	•	•	•	•	•		
Alba	(89)	•	•	•	•	•	•	•	•	•	•	•	•	•	•	•	•		
Ambassador	(4)	•	•	•	•	•	•	•	•	•	•	•	•	•	•	•	•		
Baird	(50)	•	•	•	•	•	•	•	•	•	•	•	•	•	•	•	•		
Burndept	(40)	•	•	•	•	•	•	•	•	•	•	•	•	•	•	•	•		
Bush	(62)	•	•	•	•	•	•	•	•	•	•	•	•	•	•	•	•		
Columbia	(46)	•	•	•	•	•	•	•	•	•	•	•	•	•	•	•	•		
Cossor	(86)	•	•	•	•	•	•	•	•	•	•	•	•	•	•	•	•		
Decca	(82)	•	•	•	•	•	•	•	•	•	•	•	•	•	•	•	•		
Defiant	(91)	•	•	•	•	•	•	•	•	•	•	•	•	•	•	•	•		
Dynatron	(71)	•	•	•	•	•	•	•	•	•	•	•	•	•	•	•	•		
E.M.I.	(85)	•	•	•	•	•	•	•	•	•	•	•	•	•	•	•	•		
Eddystone	(7)	•	•	•	•	•	•	•	•	•	•	•	•	•	•	•	•		
Ekco	(57)	•	•	•	•	•	•	•	•	•	•	•	•	•	•	•	•		
Elpico	(16)	•	•	•	•	•	•	•	•	•	•	•	•	•	•	•	•		
English Electric	(58)	•	•	•	•	•	•	•	•	•	•	•	•	•	•	•	•		
Etronic	(92)	•	•	•	•	•	•	•	•	•	•	•	•	•	•	•	•		
Ever Ready	(49)	•	•	•	•	•	•	•	•	•	•	•	•	•	•	•	•		
Ferguson	(77)	•	•	•	•	•	•	•	•	•	•	•	•	•	•	•	•		
Ferranti	(74)	•	•	•	•	•	•	•	•	•	•	•	•	•	•	•	•		
G.E.C.	(28, 51)	•	•	•	•	•	•	•	•	•	•	•	•	•	•	•	•		
Grampian	(110)	•	•	•	•	•	•	•	•	•	•	•	•	•	•	•	•		
H.M.V.	(84)	•	•	•	•	•	•	•	•	•	•	•	•	•	•	•	•		
Haynes	(6)	•	•	•	•	•	•	•	•	•	•	•	•	•	•	•	•		
Imhof	(93)	•	•	•	•	•	•	•	•	•	•	•	•	•	•	•	•		
Invicta	(78)	•	•	•	•	•	•	•	•	•	•	•	•	•	•	•	•		
K.B.	(52)	•	•	•	•	•	•	•	•	•	•	•	•	•	•	•	•		
McMichael	(59)	•	•	•	•	•	•	•	•	•	•	•	•	•	•	•	•		
Marconiphone	(79)	•	•	•	•	•	•	•	•	•	•	•	•	•	•	•	•		
Masteradio	(80)	•	•	•	•	•	•	•	•	•	•	•	•	•	•	•	•		
Murphy	(61)	•	•	•	•	•	•	•	•	•	•	•	•	•	•	•	•		
Peto Scott	(73)	•	•	•	•	•	•	•	•	•	•	•	•	•	•	•	•		
Philco	(54)	•	•	•	•	•	•	•	•	•	•	•	•	•	•	•	•		
Philips	(83, 90)	•	•	•	•	•	•	•	•	•	•	•	•	•	•	•	•		
Pilot	(66)	•	•	•	•	•	•	•	•	•	•	•	•	•	•	•	•		
Portogram	(115)	•	•	•	•	•	•	•	•	•	•	•	•	•	•	•	•		
Pye	(17, 65)	•	•	•	•	•	•	•	•	•	•	•	•	•	•	•	•		
R.G.D.	(76)	•	•	•	•	•	•	•	•	•	•	•	•	•	•	•	•		
Regentone	(88)	•	•	•	•	•	•	•	•	•	•	•	•	•	•	•	•		
Roberts	(44)	•	•	•	•	•	•	•	•	•	•	•	•	•	•	•	•		
Sobell	(56)	•	•	•	•	•	•	•	•	•	•	•	•	•	•	•	•		
Stella	(111)	•	•	•	•	•	•	•	•	•	•	•	•	•	•	•	•		
Ultra	(53)	•	•	•	•	•	•	•	•	•	•	•	•	•	•	•	•		
Vairadio	(21)	•	•	•	•	•	•	•	•	•	•	•	•	•	•	•	•		
Vidor	(55)	•	•	•	•	•	•	•	•	•	•	•	•	•	•	•	•		
W.B.	(60)	•	•	•	•	•	•	•	•	•	•	•	•	•	•	•	•		

ACCESSORIES : Including Materials, Valves and Non-electronic Rectifiers

FIRM	(Stand)	Aerials				Valves	C.R. tubes	Photocells	Metal rectifiers	Crystal valves	Batteries	Power units	Interference suppressors	Permanent magnets	Magnetic core materials	Magnetic recording tape or wire	Wire and cable	Insulants	Coil formers	Solder	Television pre-amplifiers	Television E.H.T. units	Television optical accessories
		Broadcast	Television and E.H.F.	Anti-interference	Car																		
Aerialite	(47)	•	•	•	•																		
Amplion	(114)	•	•	•	•						•	•											
Antiference	(94)	•	•	•	•																		
Baird	(50)																						
Belling-Lee	(64)	•	•	•	•																•		
Brown Bros.	(1077)																						•
Bulgin	(2)																						
Burndept	(40)										•	•											
Cossor	(86)					•	•																
Dubilier	(45)																						
E.M.I.	(85)	•	•	•	•						•	•	•	•							•		
Eddystone	(7)	•	•	•	•																		
Ediswan	(63)					•	•				•	•	•	•									
Ekco	(57)																						
Electron	(44A)	•	•	•	•																		
Elpico	(16)	•	•	•	•																		
English Electric	(58)																						
Etronic	(92)																						
Ever Ready	(49)																						
Ferranti	(74)																						
G.E.C.	(28, 51)					•	•																
Goldring	(35)																						
H.M.V.	(84)																						
Haynes	(6)																						
Magnavista	(31)																						
Marconiphone	(75)																						
McMichael	(59)																						
Mullard	(75)																						
Multicore	(48)																						
S.T.C.	(87)																						
Scott	(13)																						
T.C.C.	(97)																						
Telerection	(27)																						
Valradio	(21)																						
Vidor	(55)																						
W.B.	(60)																						
Wearite	(112)																						
Westinghouse	(43)																						
Wolsey	(5)																						

TEST AND MEASURING GEAR : Including Signal Generators and Test Sets

FIRM	(Stand)	Single-range pointer meters	Multi-range meters	Bridges and accessories	Valve voltmeters	Test sets	Signal sources	Television signal sources	Oscilloscopes	Test prods
Avo	(9)									
Belclere	(22)									
Bulgin	(2)									
Cossor	(86)									
E.M.I.	(85)									
Eddystone	(7)									
Ediswan	(63)									
Goldring	(35)									
Hogg	106T									
Taylor	(38)									
W.B.	(60)									
Waveforms	(34)	•								

SCIENTIFIC, INDUSTRIAL AND MEDICAL APPARATUS

FIRM	(Stand)	Radio heaters	Electronic measuring instrs.	Counters	Medical apparatus	Hearing aids
Belclere	(22)					
Cossor	(86)					
Dynatron	(71)					
E.M.I.	(85)	•	•	•	•	•
Ediswan	(63)					
English Electric	(58)					
Ossicaide	(32)					
Taylor	(38)					

(1) Waveform's 5-channel television signal generator. (2) Dubilier e.h.t. capacitor in glazed ceramic tube. (3) Amplion "Activette" unit for reactivating dry batteries. (4) G.E.C. 12-in flat-faced television c.r. tube with aluminized screen. (5) T.C.C. "Plimoseal"-treated capacitors.

SOUND REPRODUCING EQUIPMENT : Audio-Amplifiers and Electro-Acoustic Apparatus

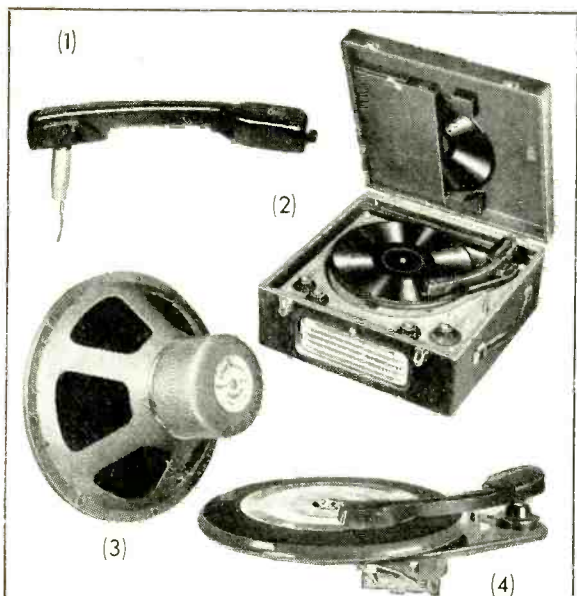

(1) Goldring magnetic turnover pickup, Model No. 165.
 (2) Pye portable radio-gramophone Type P32QTG.
 (3) Goodmans "Axiom 90." (4) Collaro Model 3/514.
 (5) "Simphonic" Model IA magnetic tape recorder.
 (6) Hunt's dual mica capacitor, Type L73, (7) Belling-Lee 18-way screened connector.

FIRM	(Stand)	Microphones	Pickups	Amplifiers	Loudspeakers	Gramophone motors	Record changers	Record players	Electric gramophones	Disc recorders	Magnetic recorders
Baird ... (50)											T
Belclere ... (22)											
Collaro ... (81)											
Connoisseur ... (12)											
Decca ... (82)											
Defiant ... (91)											
E.M.I. ... (85)											
Eddystone ... (7)											T
Ediswan ... (63)											
Ekco ... (57)											
Elpico ... (16)											
Etronic ... (92)											
G.E.C. ... (28, 31)											
Garrard ... (68)											
Goldring ... (35)											
Goodmans ... (96)											
Gramplan ... (110)											
H.M.V. ... (84)											
K.B. ... (52)											W
L. & P. Factors ... (105T)											
Marconiphone ... (79)											
Plus-a-Gram ... (25)											
Portogram ... (115)											
R.G.D. ... (76)											T
Rola-Celestion ... (39)											
Simon ... (13)											T
Trix ... (23)											
W.B. ... (60)											
Wearite ... (112)											T

D, domestic loudspeakers ; R, sound reinforcement loudspeakers ; T, tape recorders ; W, wire recorders.

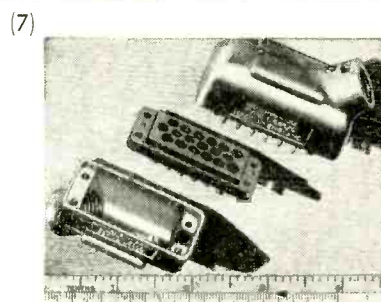
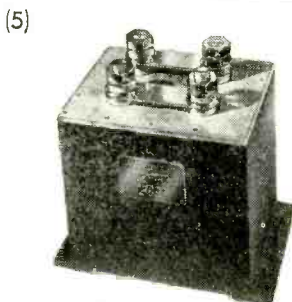
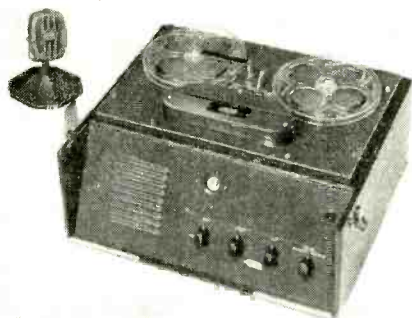

COMPONENTS : Excluding Accessories and Sub-Assemblies

FIRM	(Stand)	Capacitors, fixed	Capacitors, variable	Trimmers	Resistors, fixed	Resistors, variable	Resistors, non-ohmic	Switches	Coils, R.F.	Transformers, mains	Transformers, audio	Chokes	Plugs, sockets, connectors	Chassis fittings	Cabinets, racks, chassis	Dials, drives, knobs	Vibrators	Scanning components	Focus and ion-trap magnets
Aerialite ... (47)																			
Antiference ... (94)																			
Belclere ... (22)																			
Belling-Lee ... (64)																			
Bulgin ... (2)																			
Dubilier ... (45)																			
Eddystone ... (7)																			
Elpico ... (16)																			
Goldring ... (35)																			
Goodmans ... (96)																			
Haynes ... (6)																			
Hunt ... (95)																			
Imhof ... (93)																			
J.B. Cabinets ... (33)																			
Rola-Celestion ... (39)																			
S.T.C. ... (87)																			
T.C.C. ... (97)																			
Valradio ... (21)																			
W.B. ... (60)																			
Wearite ... (112)																			
Winrad ... (99T)																			

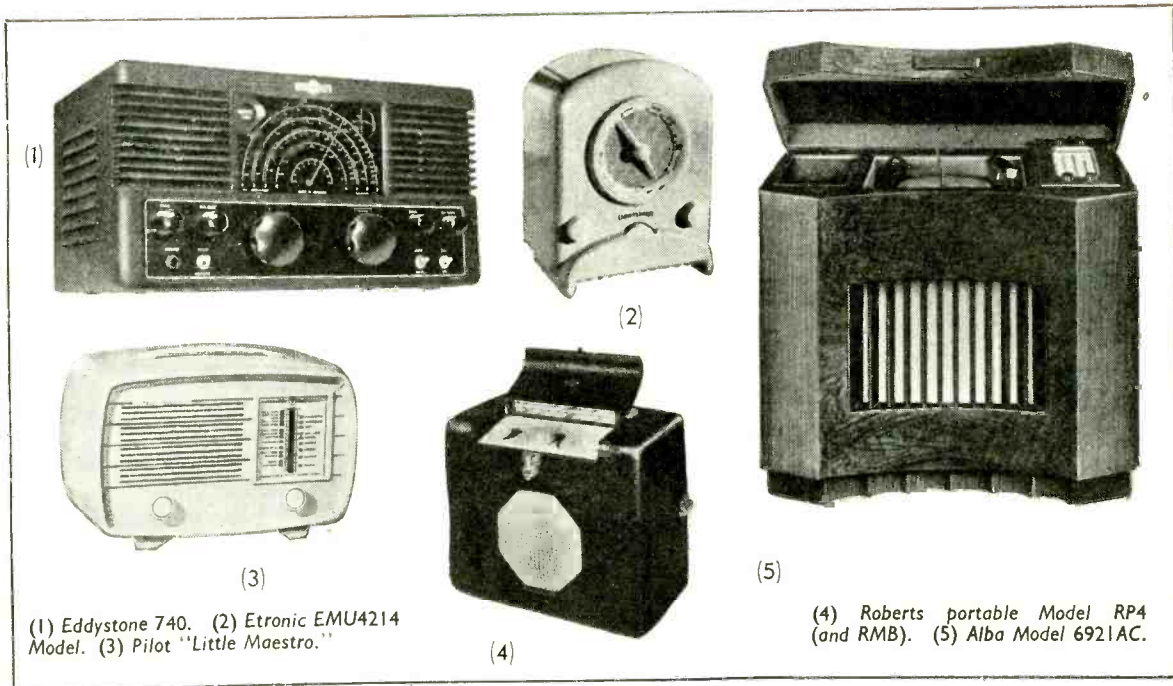

(1) Eddystone 740. (2) Etronic EMU4214 Model. (3) Pilot "Little Maestro."

(4) Roberts portable Model RP4 (and RMB). (5) Alba Model 6921AC.

NUMERICAL LIST OF STANDHOLDERS

- | | | | | | |
|----|--|-----|--|------|--|
| 2 | Board of Trade, Lacon House, Theobalds Rd., London, W.C.1. | 43 | Westinghouse Brake & Signal Co., 82, York Way London, N.1. | 84 | Gramophone Co., Hayes, Middx. |
| 3 | A. F. Bulgin & Co., Rye-Pass Rd., Barking, Essex. | 44 | Roberts' Radio Co., Creek Rd., East Molesey, Surrey. | 85 | E.M.I. Sales & Service, Hayes, Middx. |
| 4 | "Wireless & Electrical Trader," Dorset House, Stamford St., London, S.E.1. | 44A | New London Electron Works, Boleyn Rd., London, E.6. | 86 | A. C. Cossor, Cossor House, Hightbury Grove, London, N.5. |
| 5 | E. N. Fitton, Princess Works, Pollard St., Brigg house, Yorks. | 45 | Dubilier Condenser Co., Ducou Works, Victoria Rd., London, W.3. | 87 | Standard Telephones & Cables, Footscray, Sidcup, Kent. |
| 6 | Wolsey Television, 75, Gresham Rd., London, S.W.9. | 46 | Columbia Graphophone Co., Hayes, Middx. | 88 | Regentone Products, New Factory, Eastern Ave., Romford, Essex. |
| 7 | Haynes Radio, Queensway, Ponders End, Enfield, Middx. | 47 | Aerialite, Castle Works, Stalybridge, Ches. | 89 | A. J. Balcombe, 32, Tabernacle St., London, E.C.2. |
| 8 | Plessey Co., Vicarage Lane, Hford, Essex. | 48 | Multicore Solders, Mellier House, Albemarle St., London, W.1. | 90 | Philips Electrical, Century House, Shaftesbury Ave., London, W.C.2. |
| 9 | Automatic Coil Winder Co., Winder House, Douglas St., London, S.W.1. | 49 | Ever Ready Co., Hercules Place, Holloway, London, N.7. | 91 | Co-operative Wholesale Society, 1, Ballou St., Manchester, 4. |
| 10 | Avimo, Taunton, Somerset. | 50 | Scophony-Baird, Lancelot Rd., Wembley, Middx. | 92 | Hale Electric Co., Radio Works, Talbot Rd., London, W.13. |
| 11 | Econasign Co., 32, Victoria St., London, S.W.1. | 51 | General Electric Co., Magnet House, Kingsway, London, W.C.2. | 93 | Alfred Imhof, 112, New Oxford St., London, W.C.1. |
| 12 | A. R. Sugden & Co., Well Green Lane, Brighouse, Yorks. | 52 | Kolster-Brandes, Footscray, Sidcup, Kent. | 94 | Antiference, 67, Brynston St., Marble Arch, London, W.1. |
| 13 | Simon Sound Service, 48, George St., London, W.1. | 53 | Ultra Electric, Western Avenue, London, W.3. | 95 | A. H. Hunt, Bendon Valley, Garratt Lane, London, S.W.18. |
| 14 | Henry Elwin, Plumtree St., Nottingham. | 54 | Philco (Overseas), Lion House, Red Lion St., Richmond, Surrey. | 96 | Goodmans Industries, Lancelot Rd., Wembley, Middx. |
| 15 | Gamma Electronics, 518, Ipswich Rd., Trading Estate, Slough, Bucks. | 55 | Vidor, West St., Erith, Kent. | 97 | Telegraph Condenser Co., North Acton, London, W.3. |
| 16 | Lee Products, 99, Great Eastern St., London, E.C.2. | 56 | Sobell Industries, Langley Park, Nr. Slough, Bucks. | 98 | "Wireless World," Dorset House, Stamford St., London, S.E.1. |
| 17 | Pye, Radio Works, Cambridge. | 57 | E. K. Cole, Ekco Works, Southend-on-Sea, Essex. | 98T | Winter Trading Co., 6, Harrow Rd., London, W.2. |
| 18 | Geo. L. Scott & Co., Cromwell Rd., Eillesmere Port, Cheshire. | 58 | English Electric Co., Queen's House, Kingsway, London, W.C.2. | 100T | J. J. Eastick & Sons, 12, Errol St., London, E.C.1. |
| 19 | Skarsten Mfg. Co., 21, Hyde Way, Welwyn Garden City, Herts. | 59 | McMichael Radio, 190, Strand, London, W.C.2. | 101T | Hobday Bros., 21, Great Eastern St., London, E.C.2. |
| 20 | Barclays Bank, 54, Lombard St., London, E.C.3. | 60 | Whiteley Electrical Radio Co., Victoria St., Mansfield, Notts. | 102T | Kerry's, Warton Rd., London, E.15. |
| 21 | Valradio, New Chapel Rd., Feltham, Middx. | 61 | Murphy Radio, Welwyn Garden City, Herts. | 103T | Petter Radio & Electrical Supplies, 201-9, Forest Rd., London, E.17. |
| 22 | John Bell & Croydin, 117, High St., Oxford. | 62 | Bush Radio, Power Rd., Chiswick, London, W.4. | 104T | Bernards, The Grampians, Western Gate, London, W.6. |
| 23 | Trix Electrical Co., 1-5, Maple Place, Tottenham Court Rd., London, W.1. | 63 | Edison Swan Electric Co., 155, Charing Cross Rd., London, W.C.2. | 105T | London & Provincial Factors, 230, Tottenham Court Rd., London, W.1. |
| 24 | "British Radio & Television," 92, Fleet St., London, E.C.4. | 64 | Belling & Lee, Cambridge Arterial Rd., Enfield, Middx. | 106T | F. Livingston Hogk, 77, Wood Vale, London, N.10. |
| 25 | J. & A. Marrolin, 112-116, Old St., London, E.C.1. | 65 | Pye, Radio Works, Cambridge. | 107T | Brown Brothers, Brown's Buildings, Great Eastern St., London, E.C.2. |
| 26 | National Provincial Bank, 15, Bishopsgate, London, E.C.2. | 66 | Pilot Radio, 31-37, Park Royal Rd., London, N.W.10. | 108T | Horace Dibben, Upper Bauster St., Southampton, Hants. |
| 27 | Telerection, 19, Suffolk Parade, Cheltenham, Glos. | 67 | Association of Radio Battery Manufacturers, 41, Gordon Square, London, W.C.1. | 109T | L.E.S. Distributors, 15, Alfred Place, London, W.C.1. |
| 28 | General Electric Co., Magnet House, Kingsway, London, W.C.2. | 68 | Garrard Engineering & Mfg. Co., Newcastle St., Swindon, Wilts. | 110 | Gramphon Reproducers, Hanworth Trading Estate, Feltham, Middx. |
| 29 | J. & S. Newman, 100, Hampstead Rd., London, N.W.1. | 69 | British Railways, 222, Marylebone Rd., London, N.W.1. | 111 | Stella Radio & Television Co., 9-15, Oxford St., London, W.1. |
| 30 | "Practical Wireless," Tower House, Southampton St., London, W.C.2. | 70 | Dynatron Radio, Perfecta Works, Ray Lea Rd., Maidenhead, Berks. | 112 | Wright & Weaire, 138, Sloane St., London, S.W.1. |
| 31 | Metro Pex, 42A, Denmark Hill, London, S.E.5. | 71 | Westminster Bank, 51, Threadneedle St., London, E.C.2. | 113 | "Electrical & Radio Trading," 96, Long Acre, London, W.C.2. |
| 32 | Ossicade, 1, Upper Richmond Rd., London, S.W.15. | 72 | Peto Scott Electrical Instruments, Adlestone Rd., Weybridge, Surrey. | 114 | Amphon, 230, Tottenham Court Rd., London, W.1. |
| 33 | J.B. Manufacturing (Cabinets) Co., 86, Palmerston Rd., London, E.17. | 73 | Ferranti, Hollowood, Lancs. | 115 | Portogram Radio Electrical Industries, Prell Works, St. Rude St., London, S.W.1. |
| 34 | Waveforms, 26, Oakleigh Rd., London, N.11. | 74 | Mullard, Century House, Shaftesbury Avenue, London, W.C.2. | 231 | Admiralty, Whitehall, London, S.W.1. |
| 35 | Erwin Scherl, 49, De Beauvoir Rd., London, N.1. | 75 | Radio Gramophone Development Co., Pale Meadow Print Works, Bridgforth, Shropshire. | 232 | Air Ministry, Parliament Square House, Parliament St., London, S.W.1. |
| 36 | Television Society, 68, Compton Rd., London, N.21. | 76 | Ferguson Radio Corporation, 105, Judit St., London, W.C.1. | 233 | General Post Office, Headquarters, London, E.C.1. |
| 37 | "Electronic Engineering," 28, Essex St., London, S.W.2. | 77 | Inventa Radio, Parkhurst Rd., London, N.7. | 234 | War Office, Whitehall, London, S.W.1. |
| 38 | Taylor Electrical Instruments, 419, Montrose Avenue, Slough, Bucks. | 78 | Marconiphone Co., Hayes, Middx. | 235 | Dept. of Scientific & Industrial Research, Charles House, 5-11, Regent St., London, S.W.1. |
| 39 | Rola Celestion, Ferry Works, Sumner Rd., Thames Diton, Surrey. | 79 | Masteradio, 10-20, Fitzroy Place, London, N.W.1. | 236 | Ministry of Civil Aviation, Ariel House, Theobalds Rd., London, W.C.1. |
| 40 | Buradep, West St., Erith, Kent. | 80 | Collaro, Ripple Works, Bye-Pass Rd., Barking, Essex. | 237 | British Broadcasting Corporation, Broadcasting House, London, W.1. |
| 41 | Ace Radio, Tower Works, Tower Rd., Pound Lane, London, N.W.10. | 81 | Decca Record Co., 1-3, Brixton Rd., London, S.W.9. | | |
| 42 | Lloyds Bank, 71, Lombard St., London, E.C.3. | 82 | Philips Electrical, Century House, Shaftesbury Ave., London, W.C.2. | | |

LETTERS TO THE EDITOR

The Editor does not necessarily endorse the opinions expressed by his correspondents

B.B.C./G.P.O. Standards

C. R. WHITE'S letter in your July issue reveals a situation, if the facts are as stated, which is shocking. It is very regrettable that the B.B.C., which is obliged to publish an annual report to show what it does with our money, is not also obliged to declare annually its standard of technical achievement. All the hush-hushery which surrounds the quality of B.B.C. equipment and G.P.O. lines should be done away with before the possibility of spending £200,000 on even one v.h.f. station is given a moment's consideration.

B.B.C. quality as heard here in Edinburgh does seem to have improved in the last few months, but even so I can hear little difference in fidelity between live and recorded material, and what difference there is often in favour of the disc. Programmes originating in Scotland and broadcast in this region only do not seem to be of better technical quality than those which are piped from London, or, worse still, are piped down to London for control purposes and then piped back up again to the local transmitter. This suggests that the transmitter causes the main loss of quality.

A merely moderately good tape recording covering a frequency range of 100 to 7,000 cycles sounds to most people greatly superior to the average B.B.C. transmission, while speech over a good closed circuit often shakes them visibly. Film recording, involving electrical, chemical and physical processes can also be highly successful, to say nothing of the humble disc, slowly edging its way up to the 20,000-cycle mark. What prevents broadcasting from being *at least* as good?

Edinburgh, 9.

W. J. MACLEAN.

ON the evening of July 7 Droitwich was radiating a programme of dance music relayed from the Continent and between 11.00 and 11.15 p.m. this emanated from the German N.W.D.R. system in Hamburg.

From the moment the German transmission commenced the whole balance of the frequency characteristic was improved and there was no audible intermodulation buzz. Although I do not suggest that this was a perfect transmission I was so impressed that I waited to compare with it the ensuing programme from London. The instant the English announcer spoke, back came that intolerable harshness and transient buzzing effects that we have for so long had to tolerate on the majority, though not all, of our programmes.

Does this not demonstrate the important fact that the above-mentioned distortion does not originate in the B.B.C.'s main modulators, or even in the much maligned land lines, but in the microphones or early audio amplifiers at the studios? I feel somehow that it is bound up with the B.B.C. rising top characteristic (as we know, top lifting increases the harmonic content).

Wednesbury, Staffs.

A. A. COTTERELL.

YOUR correspondent C. R. White poses the question whether the B.B.C. has a different standard for the provinces than for London. As a Northern listener anxious to obtain the best quality I can afford and who has long suffered the vagaries of the Moorside Edge transmitters (Home 434 m and Light 247 m) I do not think there can be any doubt that the reply is in the affirmative. Indeed, it is not too much to say that the whole B.B.C. set-up for provincial broadcasting is such as to make a lower standard inevitable.

I had for some time been puzzled by the fact that the quality of broadcasts known to originate in local studios was noticeably poorer than that of programmes coming by landline from London. In February of this year I wrote to the B.B.C. on the matter. They stated that normally

all broadcasts of provincial origin, whether in Home or Light programmes are routed via London, which in the case of the Manchester studios must involve nearly 200 miles of landline instead of the 20-odd miles from Manchester to Moorside Edge. Poor quality is thus inevitable under present G.P.O. landline standards. The only apparent reason for this curious system is to give London direct control of provincial studio's output. It is significant of this that my original letter to the B.B.C. in Manchester, though concerned solely with Northern transmission quality, was acknowledged with the intimation that the complaint was a matter for London, and the ultimate reply came from the Engineering Information Department there.

It would seem that provincial listeners contemplating the purchase of high-fidelity equipment should ask themselves whether the substantial expenditure involved is worth while under current conditions, unless they are fortunate enough to be in the service area of the new Third Programme transmitter at Daventry, which, though about 100 miles distant, gives much better quality in the Manchester area than either of the local Home and Light medium-wave stations.

Manchester.

J. BRAMALL.

The Innocent Pentode

"DIALLIST," in your July issue, repeats an ancient libel on the innocent pentode. He charges it with producing high harmonics, amplifying high frequencies more than low, and even amplifying its own harmonics. Can these things be true?

Manifestly, the pentode does not amplify high frequencies more than low: the mutual conductance is constant. But if the load impedance rises, the gain will rise, and this effect is not offset in the pentode, as it is in the triode, by a high input capacitance.

When used at the same efficiency, the pentode produces less distortion than the triode. But it can be operated over almost the full anode voltage, and then it runs more sharply against end-stops, and the high harmonics rise. There is another source of distortion, and this may be in "Diallist's" mind when he states that the pentode amplifies its own harmonics. When the cathode is not decoupled, and the screen is at a.c. earth, and not at a.c. cathode, the screen current is in the feedback loop. The screen current, being a triode current, is severely distorted, and this feedback increases the distortion.

The bad reputation of the pentode is the result of careless circuit design: it is not the car which kills, but the driver. Feedback is used to make up for deficiencies in output transformer design and then, with such large phase shifts that the feedback is positive at high audio frequencies, the valve is blamed for the increased distortion. Instead of improving the design, the designer cries loudly that triodes were good enough for his father, and they are good enough for him: 10 per cent distortion was good enough for his father, too.

No, Sir: "Diallist" must suppress these reactionary thoughts and must be screened from the triodomaniacs. This is no time to lay down the slide-rule.

THOMAS RODDAM.

Bass Without Big Baffles

I MUST thank your correspondents G. A. Briggs and O. G. Kerslake (your August issue) for their generous remarks concerning the performance of my amplifier.

In case readers should be discouraged by Mr. Briggs' revelation that I use a "doctored" loudspeaker, perhaps I had better say a few words about this. The "operation" merely consisted of removing a pair of diametrically oppo-

site limbs of a four-limbed central spider with scissors.

The loudspeaker (with a cloth surround to the cone) had a specified fundamental resonance at 45 c/s, and, by thus increasing the compliance of the central spider, this figure was reduced to the region of 30 c/s. I believe that a really smooth bass response (in terms of the fundamental or of artificially produced harmonics) can only be obtained if a loudspeaker with a low natural resonance is used. However, my circuit was originally evolved round a cheap 10-inch speaker and a cabinet with a frontage of 2½ ft by 1½ ft, and gave excellent results. Dimensions such as those (or less) come into my category of "small baffles."

It may be that Mr. Briggs is under the impression that spurious harmonics at higher frequencies are removed in my amplifier by filtering. This is not so, since the filter precedes the distorting valve V_3 and limits frequencies admitted to V_3 to those lying below about 100 c/s. It is on the presence of a full range of harmonics appearing at the anode of V_3 that the effectiveness of the circuit is dependent.

There would seem, from personal correspondence which I have received, some demand among readers for information regarding suitable valve substitutes, etc. The following list of Osram equivalents (or near equivalents) should prove useful:—

For 6SF5 substitute Osram H63.

For 6J5 substitute Osram L63.

For EL33 substitute Osram KT61.

If the last-mentioned output valve is employed the value of the cathode bias resistor R_{16} should be altered to 90 ohms. Otherwise no circuit modifications need be made.

Regarding a suitable output transformer, I can recommend a Wharfedale W12, using tapings giving a ratio of 22:1 for the 15-ohm speech coil.

Snags in the form of instability are common with high-slope output valves such as those specified. Leads to and from the output transformer should be kept as short as possible, and leads at the input end of the amplifier should be screened. The small capacitor C_{10} was included in order to improve stability and its value may be varied accordingly. In some layouts this item may best be omitted altogether.

K. A. EXLEY.

Leeds, 6.

WHY all this talk about synthetic "bass"? Recently after hearing a concert in the Royal Festival Hall, seated where the volume level seemed comparable with that of a 10-W amplifier at close quarters, I certainly had no desire to go home and introduce abnormal bass emphasis. On the assumption that the experts who dealt with the acoustics of the Festival Hall were right, I found it necessary to return my bass lift circuit to "flat" on my Voigt equipment to approximate to what I was hearing at that concert.

E. R. VEATER.

Hayle, Cornwall.

Valve Priorities

ON page 166 of your April, 1951, issue, "Free Grid" asks whether de Forest devised a valve with grid in 1912 only, since a German named von Bronck had discovered high-frequency amplification already in 1911. "Free Grid" therefore assumes that the invention was made by de Forest before 1911.

It is correct that von Bronck discovered high-frequency amplification in 1911. (See German Patent 271,059.)

De Forest devised in 1907 the gas-containing Audion valve which had a grid, see U.S.A. Patent 879,532. This valve was, however, not intended to be an amplifier valve but a receiving detector valve and, at the time, could not hold its own against the crystal detector, since it had rather low sensitivity.

Knowledge of amplifier valves came to us in Europe through another inventor, R. von Lieben, who invented

the amplifier valve in 1910, see German Patent specification 249,142 (corresponding Austrian Patent 54,011).

Stuttgart, Germany. TELEFUNKEN G.m.b.H.

Diathermy Interference

IT would appear that a great many of the hospital diathermy equipments in use throughout the country are tuned to the same frequency as the Holme Moss television station.

In York and many West Riding towns, to my personal knowledge, radiation from these equipments is causing such serious interference that reception of the Holme Moss station will be impossible while they are operating. What action do the authorities concerned propose to take to eliminate this interference?

R. CUSSINS.

Cussins and Light, Ltd., York.

Intermodulation Tesis

I READ with interest the article in the July issue on "Intermodulation Distortion in Gramophone Pickups." Recently I have been making a series of intermodulation distortion measurements on various pickups (using a test set which I am confident avoids the pitfalls mentioned by Mr. Berth Jones in the June issue) and I am surprised at the emphasis placed by Mr. Kelly on the application of this particular form of measurement to checking the tracking capabilities of a pickup.

The minimum needle pressure required for a given pickup to track a given frequency recorded at a given level can be determined correct to at least ½ gram by the observation of waveform on an oscilloscope. The waveform produced by failure to track has a characteristic "spiked" appearance and a very small trace of this form of distortion is easily detectable.

The intermodulation distortion method can certainly be used to check the tracking capabilities of a pickup at the modulation frequency (although in my view it is an over-elaborate method). With the record discussed (JH138) this can be done at 60 c/s and 400 c/s for the maximum recording level at those frequencies; but this does not necessarily indicate the tracking capabilities of a pickup with a bass mechanical impedance resonance at 40 c/s, or worse still at 80 c/s. Further, in the case of a cantilever crystal pickup with a bass resonance at, say, 35 c/s and a treble resonance at, say, 10,000 c/s, the minimum needle pressure required may be determined by the impedance at the high-frequency resonance, i.e., although the pickup may track perfectly at 60 c/s (+8.6 db recorded level relative to 1 cm/sec) with a given needle pressure, a higher needle pressure will be required for perfect tracking at 10,000 c/s and the same recorded level (well below the maximum recording level at this frequency). The only answer would be a large number of intermodulation test records with a corresponding number of interchangeable filters in the test set! A relatively small number of high-level, single-frequency records (whose frequency can be varied by a variable speed turntable) and a reasonably good oscilloscope provide a far simpler method.

I suggest that the importance of intermodulation distortion measurement for pickups lies in that it is a sensitive and convenient way of measuring non-linearity when the pickup is actually tracing the record groove modulations satisfactorily. In this respect a small difference in intermodulation distortion between two pickups (as measured on the 400 c/s-4,000 c/s side of the record) is definitely detectable by ear when playing orchestral music records. In fact, within reasonable limits, intermodulation distortion measurements would appear to be as important as frequency range or response curve in judging the performance of a pickup. I have found so far that the critical unbiased listener will invariably express preference for lower intermodulation distortion rather than better frequency response.

L. J. ELLIOTT.

London, N.W.3.

Stereophony on Television Channels

Proposals for Binaural Broadcasting

WHEN the P.M.G. made his famous statement on a new system of broadcasting, was he, by any chance, referring to stereophony? Probably not, considering how many times the official wet blanket has been cast on the idea. Yet the fact remains many technical people still regard stereophonic broadcasting as *the* thing of the future. And, unlike the Chief Engineer of the B.B.C.,* they do not see overwhelming objections in the fact that two sound channels are necessary—especially in these days of multichannel radio links. The stereophonic broadcast staged in France last year did, certainly, require two complete chains of equipment from microphone to loudspeaker, and it was rather cumbersome—but then, after all, the B.B.C. used fundamentally impractical methods to show the world that a public television service was a practical possibility.

One of these devotees of stereophonic broadcasting, H. H. Olofsen, of Hilversum, Holland, has written to us expressing his faith in the idea and suggesting how an experimental system might be put into effect without too much trouble. He demolishes the main argument against the scheme—that we can't afford to set up duplicate systems because of the cost and the lack of space in the ether—by pointing out that we in Britain already have a system of duplicate transmitters and receivers standing idle for large parts of the day and just asking to be used. He has in mind the television system, with its vision and sound transmitters and corresponding dual arrangements in the receivers. Mr. Olofsen proposes, in fact, that the vision transmitter should be used for the second sound channel, so that in the television receiver it would only be a matter of switching the video output from the cathode ray tube to a second loudspeaker.

The scheme is simple and certainly worth a trial. Plenty of enthusiasts would be willing to convert their television receivers, but what about the B.B.C.? Unfortunately, its attitude can be predicted only too clearly from the fact that last year it rejected a proposal for radiating binaural programmes from the twin transmitters at Wrotham. Perhaps, too, its sense of economy would recoil at the suggestion of using a vision channel of 3-Mc/s bandwidth for a mere 15-kc/s sound spectrum. Certainly this would be wasteful. But here Mr. Olofsen comes forward again, with a proposal for utilizing this wide bandwidth to the full. He points out, in fact, that it would accommodate quite a large number of sound channels. So far from one stereophonic programme monopolizing two transmitters and receivers, he says, four stereophonic programmes could be radiated from a single transmitter and received on a single televisor.

A multiplexing system would, of course, be necessary to achieve this, and one which would utilize the existing vision transmitting and receiving circuitry to

the best advantage, with a minimum of alteration and change-over switching. Our correspondent suggests a time-division multiplexing system using pulse modulation. Each of the four programmes modulates a separate train of pulses and the trains are staggered so that they interlace to form a single, more closely packed pulse train. This is transmitted in place of the usual vision waveform. In the television receiver the individual pulse trains are selected by gate circuits—Mr. Olofsen thinks the time-base circuits could be adapted for this purpose—and so the four programmes are reconstituted. The operation of the gate-pulse generators is controlled by the original television sync. pulses, which are retained in the signal and separated in the usual way in the receiver. So far so good, but what about the two sound channels necessary for each programme? To accommodate these, Mr. Olofsen proposes to make the pulses in each train alternate in width and modulate one channel on to the narrow pulses and the other on to the wide ones. Then, in the receiver, a pulse-width discriminator separates them and so obtains the two channels. He adds that the system would be suitable for carrying "hyper-high-note" monaural programmes as a possible alternative experiment to the stereophony.

Incidentally, our correspondent makes the further suggestion that an extra channel could be provided by modulating the sync. pulses themselves. In fact, as "Cathode Ray" mentioned in "Sampling" last month, Pye have already tried a similar sort of scheme for carrying the sound of a television programme, the idea being, of course, to obviate the separate sound transmitter. "Cathode Ray" also posed the question: "Is it (sampling) the Answer to the Wavelength Problem?" Mr. Olofsen thinks that his multichannel scheme might well be. He suggests that all national and regional programmes could be distributed in this way, so that the medium waves would then be left free for such things as programme exchanges between countries. Thus our present sound broadcast receivers would become redundant and we should get all our programmes, television and sound, from the same box.

Undoubtedly this would be a welcome innovation to the average listener-viewer who at present must have either two separate sets or an equally expensive combined model. For the B.B.C., however, it would raise the new problem of how to share the available hours of the day between television and sound—and, until such time as the mounting pace of life forces us all to develop multichannel minds, it would need to be time division *without* multiplex. But at the moment, unless the B.B.C. has immediate plans for making television a 24-hour service, there would be no organizational difficulties in sharing the channels with stereophony, and, as Mr. Olofsen points out, it would give "full employment" to the transmitters.

* *Wireless World*, April, 1950, p. 158.

WORLD OF WIRELESS

Modulation Muddle ♦ I.T.U. Geneva Conference ♦ Record Radio Exports ♦ Audio Engineering Convention

A.M.-F.M. Controversy

A FURTHER complication in the a.m.-f.m. controversy has been caused by the United States' request that we in this country should, "in the interests of world standardization," reconsider the decision to use a.m. for our single-channel v.h.f. maritime radio services.

When asked in the House of Commons if he would give an assurance that he intended to maintain his declared policy on this question the P.M.G. stated that discussions with U.S. representatives had not yet taken place but, as matters stood, he proposed to support the case for amplitude modulation in any international discussions.

Reference was made to this question recently by C. O. Stanley, chairman of Pye, Ltd. He stated that during the three years since the decision was made to use a.m. for v.h.f. maritime telephone services the G.P.O. had "failed to equip a single British port with the necessary shore facilities" despite the fact that manufacturers had the equipment available. He added that the countries now pressing for a change in our policy "can point to substantial progress in this field, whereas Britain can point to none."

International Conference

SINCE the Atlantic City Conference in 1947 a number of meetings have been held in order to prepare plans for the allocation of frequencies to specific services or, as in the case of the Copenhagen Conference, to a service in a given area. Whilst some of these have had plenipotentiary powers, others have been purely investigatory. Now a conference is in progress in Geneva—it opened on August 16th—to confirm and, where necessary, modify the plans drawn up at these meetings for the allocation of frequencies between 14 kc/s and 27.5 Mc/s to the four main services. Where, as in the case of the Rapallo conference, a complete plan was not produced the present conference will be called upon to work out methods for drawing up new plans.

The conference has also to determine the role of the International Frequency Registration Board in the implementation of the new allocation tables.

The U.K. delegation, which will be led by Sir Robert Craigie, includes representatives of the Post Office, B.B.C., Armed Services, Foreign Office and Ministry of Civil Aviation.

Among the Post Office delegates are Col. A. H. Read (Director of Overseas Telecommunications), S. Horrocks (Telephone and Radio Branch), C. F. Booth (Radio Development Branch), E. Potts (U.K. representative on the Provisional Frequency Board) and R. M. Billington, whose main interest is in maritime mobile services in the U.K. The B.B.C. representative is W. J. Chalk.

Radio Exports

EXPORTS of radio equipment in the first six months of this year reached a record value of £10,195,333, which was 39.4 per cent more than the figure for the same period in 1950.

The biggest increase was in the export of receivers which rose by 74 per cent to £2,110,824. Loose components exported were valued at £3,387,892, of which approximately 10 per cent went to the U.S.A. and Canada. Exports of valves rose by 54 per cent to £1,817,171. Capital equipment (broadcast transmitters, communications equipment, navigational aids, etc., not including installations in ships and aircraft) increased by 12.6 per cent to £2,646,618.

According to the Radio Industry Council radio exports now form the highest single group among exports of the electrical industry.

Business Radio

WHEN questioned in the House of Commons on the Government's policy regarding the use and expansion of mobile radio services, the P.M.G. gave details of the number of licences in force at the end of July.

Taxis, hire cars, delivery vans, etc., head the list with 243 licences covering 222 fixed stations and 1,054 mobile stations. Police and fire services had 182 licences (428 fixed and 2,403 mobile stations); harbour and tug services, 65 (74 and 258); public utility services, 53 (61 and 221); ambulances, 19 (20 and 266); contractors, works, etc., 12 (8 and 62); and railways, 8 (7 and 41). This gives a total of 582 licences, 820 fixed stations and 4,305 mobile transmitters.

Audio Convention

THE sixth and last session of the Brit. I.R.E. Convention, which will be devoted to the subject of audio-frequency engineering and acoustics, will be held from September 4th to 6th in the Richmond Hall, Earls Court, during the period of the National Radio Exhibition.

Admission to the convention, which will be under the chairmanship of H. J. Leak, is by ticket obtainable from the secretary of the Institution, 9, Bedford Square,



HOLME MOSS. Medium-power stand-by transmitters (5kW vision, 2kW sound) installed by Marconi's at the B.B.C.'s northern television station which is to be opened by the P.M.G. on October 12th. The transmitters are similar to those originally ordered for the five secondary stations.

London, W.C.1. The registration fee for the session is 10s 6d.

Most of the fourteen papers to be read will include demonstrations, and the session will conclude with a discussion on high-fidelity reproduction in which both technicians and musicians will be invited to take part.

The papers are:—

- “The Royal Festival Hall: Acoustic Design and Testing,” by P. H. Parkin, B.Sc. (D.S.I.R. Building Research Station).
- “Some Aspects of Magnetic Recording and Reproduction,” by O. K. Kolb, Ph.D. (British Acoustic Films).
- “Problems in Magnetic Recording, with particular reference to Film Production,” by N. Leever, B.Sc., A.C.G.I. (Leever Rich).
- “Microgroove Recording,” by N. C. Mordant and E. D. Parchment (Decca).
- “Loudspeaker Baffles and Cabinets,” by J. A. Youngmark, M.A. (Goodmans).
- “Stereophonic Reproduction using a 3-channel System,” by J. Moir, M.I.E.E. (B.T.H.).
- “Intermodulation Distortion: Its Significance and Measurement,” by E. Berth-Jones, B.Sc.(Eng.) (E.M.I. Studios).
- “Loudspeakers: Relations between Subjective and Objective Tests,” by F. H. Brittain (Acoustics Division, G.E.C.).
- “The Mechanics of Hearing,” by T. S. Littler, M.Sc., Ph.D. (Wernher Research Unit on Deafness).
- “The Loudspeaker in the Home,” by P. J. Walker (Acoustical Manufacturing Co.).
- “Electrophone Organs,” by L. E. A. Bourne (Compton Organ Co.).
- “Speech Input Systems for Broadcast Transmitters,” by S. Hill, M.Sc. (Standard Telephones Cables).
- “Piezo-Electric Crystal Transducers,” by S. Kelly (Cosmocord).
- “Objective Testing of Pickups and Loudspeakers,” by K. R. McLachlan and R. Yorke, B.Eng., B.Sc. (University College, Southampton).

Broadcasting Station Guide

ALTHOUGH the Copenhagen Plan has now been in use for some eighteen months the situation in the l.w. and m.w. bands is still far from satisfactory. There is continuous jockeying among certain stations to get better positions. According to the latest available details there are nearly 200 stations operating on unauthorized frequencies; many of them sandwiched between the agreed channels.

The situation can best be visualized by perusing a copy of the latest edition (6th) of our 96-page book, “Guide to Broadcasting Stations,” which includes operating details of some 360 authorized and 190 unauthorized long- and medium-wave transmitters in Europe. Details of some 1,400 short-wave broadcasting stations throughout the world are also given in the book, which is available from booksellers price 2s., or by post from our Publisher, price 2s 2d.

The substantial growth in the use of metre-wave broadcasting in Europe is shown by the increased number of stations listed; 46 as compared with 11 in the last edition. The contents also includes: European television stations, Consol and standard frequency transmitters, international call signs, standard time throughout the world and wave-length-frequency conversion tables.

Price Cutting and Service

WE reported in last month's issue the plea that the provision of “after-sales” service in such “technical” industries as radio and television called for some special dispensation in regard to the Government's proposed abolition of retail price maintenance.

The Board of Trade has now announced that special consideration is being given to “certain technical goods, such as motor cars, radio and television.”



DR. D. C. ESPLY, O.B.E.
(See “Personalities”)

Valve Making

IN his opening remarks as chairman of the valve session of the Brit. I.R.E. Convention, J. R. Hughes, who at short notice took the place of J. W. Ridgeway, spoke of the empiricism of valve making and of the difficulties of standardization in view of this. But, he asserted, “the main obstacle to standardization is the valve user.”

There are, he pointed out, no second chances in valve making; it is a case of “one-shot” production—a valve is either usable or unusable. He also touched upon the present-day demands for miniaturization, smaller heater and filament current, operation at higher frequencies and reliability.

I.E.E. Awards

PREMIUMS have been awarded by the I.E.E. for twelve papers read before the Radio Section, or accepted for publication, during the 1950/51 session. In addition, the John Hopkinson Premium, which is not confined to a Section, is awarded to R. J. Clayton, Dr. D. C. Espley, G. W. S. Griffith and J. M. C. Pinkham for their paper “London-Birmingham Television Radio Relay Link,” and the Heaviside Premium to Dr. G. G. Macfarlane and Mrs. A. M. Woodward for their paper “Small-signal Theory of Wave Propagation in a Uniform Electron Beam.”

The Radio Section Duddell Premium is awarded to P. A. T.

Bevan and H. Page for their paper “Sutton Coldfield Television Broadcasting Station” and the Ambrose Fleming Premium to Dr. J. A. Saxton, G. W. Luscombe and G. H. Bazzard for their two papers on “Propagation of Meter Radio Waves between the Normal Horizon.”

Extra premiums are awarded for the following papers:—

“The Vision Transmitter for the Sutton Coldfield Television Station” (E. A. Nind and E. McP. Leyton); “Low-Frequency Radio-Wave Propagation by the Ionosphere, with particular reference to Long-Distance Navigation” (Caradoc Williams); “Frequency Standardization” (Dr. L. Essen); “The Use of Saturable Reactors as Discharge Devices for Pulse Generators” (W. S. Melville); “Crystal Diodes” (R. W. Douglas and Dr. E. G. James); “An Automatic Monitoring of Broadcast Programmes” (H. B. Rantzen, F. A. Peachey and C. Gunn-Russell); “Factors Governing the Radiation Characteristics of Dielectric Tube Aerials” (D. G. Kiely); “Cheese Aerials for Marine Navigational Radar” (D. G. Kiely, Instr. Lieut. A. E. Collins, R.N., and G. S. Evans); and “Some Properties of Wave Guides with Periodic Structure” (Dr. A. W. Lines, G. R. Nicoll and Mrs. A. M. Woodward).

PERSONALITIES

D. C. Espley, O.B.E., D.Eng., the chairman of the I.E.E. Radio Section for the next session, has been in the Research Laboratories of the G.E.C., Wembley, since 1930. He is in charge of telecommunications research activities at the laboratory and was responsible for the design, development and installation of the London-Birmingham television radio-relay link.

J. A. Smale, B.Sc., who has been elected vice-chairman of the I.E.E. Radio Section, is chief engineer of Cable & Wireless, Ltd. He joined the Engineer-in-Chief's Dept. of C. & W. in 1932 and was responsible before the war for the development of long-



J. A. SMALE, B.Sc.

distance s.w. relay stations as a means of overcoming unfavourable propagation conditions. He also originated important development work on frequency-shift keying.

Dr. H. G. Booker, who went to the U.S.A. in 1949 as Professor of Electrical Engineering at Cornell University, was recently appointed chairman of the U.S.

Navy advisory board on aerials. He was at one time in charge of the Mathematics Section of the Telecommunications Research Establishment of the Ministry of Supply.

R. B. Dome, the engineer in the American General Electric Company's laboratories responsible for the development of the frequency-interlace system of colour television described in our December, 1950, issue, has been awarded the Morris Liebmann Memorial Prize by the American I.R.E. for "... his contributions to the inter-carrier sound system of television reception. . . ."

IN BRIEF

Broadcast Licences.—The increase in the number of "sound" receiving licences in the U.K. is counter-balanced by the withdrawals of "sound" for "vision" licences so that there is now a gradual decrease in the former. At the end of June the number of "sound" licences totalled 11,562,800 a decrease of 7,900 during the month. Vision licences increased by 27,800 to 897,000. The overall totals were May, 12,439,900; June, 12,459,800.

D.G. Radio Production.—The Government has decided to set up a Radio Advisory Council through which liaison between the Ministry of Supply and the radio industry can be maintained on matters affecting defence. When announcing this in the House the Minister of Supply stated that a Director-General of Radio Production would be appointed to act for the Ministry.

Unadvised!—The P.M.G., in reply to a question in the House, stated that the Television Advisory Committee, which was reconstituted on the appointment of the Beveridge Broadcasting Committee, had not met since November 4th, 1949.

Educational Opportunities.—Prospectuses covering both day and evening courses in telecommunications, television and radio theory, servicing and the amateur transmitter's examination, for the 1951-1952 session have been received from The Polytechnic, Regent Street, London, W.1; South East London Technical College, Lewisham, S.E.4; and Brentford Evening Institute, Brentford, Middlesex.

B.S.R.A. Officers.—C. E. Watts has been elected president of the British Sound Recording Association for the second year and M. J. L. Pulling and B. C. Sewell re-elected vice-presidents. H. Davies and H. J. Leak were also elected vice-presidents.

RECORDING ROOM, housing twelve disc and eight tape recorders, in the new headquarters of the Canadian Broadcasting Corporation. The control panel for each recorder is fitted with an automatic programme selector switch by means of which any one of 50 outlets from the Master Control Room can be recorded.



I.E.E. Council.—Among those elected to office on the Council of the Institution of Electrical Engineers for the ensuing year are the following members of the Radio Section:—Dr. W. G. Radley (G.P.O.) a vice-president; and Dr. J. L. Miller (B.I. Callender's Cables) and Prof. F. C. Williams (University, Manchester) ordinary members.

I.E.E. Radio Section.—The following have been elected to fill the vacancies occurring on the Radio Section Committee on September 30th:—Chairman, Dr. D. C. Espley (G.E.C.); vice-chairman, J. A. Smale (Cable and Wireless); ordinary members, G. Millington (Marconi's), Dr. E. L. C. White (E.M.I.) and W. E. Willshaw (G.E.C.).

R.S.G.B. Call Book.—The first edition of the R.S.G.B. Amateur Radio Call Book, which contains the names and addresses of some 6,000 amateur transmitters in the British Isles and the Irish Republic, is available by post from the Society at New Ruskin House, Little Russell Street, London, W.C.1, price 3s 9d, including postage.

Advice to potential viewers on such matters as size of screen, type of aerial and operation of a television set, is given in the illustrated 28-page booklet "What you need to know about TV" which is being issued free by Pye, Ltd., Cambridge.

B.I.F.—Next year's British Industries Fair will be held from May 5th to 16th in both London and Birmingham.

INDUSTRIAL NEWS

British transmitting and receiving gear has been chosen by the authorities in Bogota, Colombia, for their television service. Marconi's are supplying the 525-line transmitter and associated studio equipment whilst Ekco receivers will be available from the Municipality under a hire-purchase scheme.

Ekco.—To mark the silver jubilee of the formation of E.K. Cole, Ltd., the annual report and statement of account is issued as an illustrated brochure. It recalls that the company was formed in 1926 to market the Ekco battery eliminator.

Television Afloat.—Pye, Ltd., are operating through their subsidiary company Rees Mace Marine, Ltd., a service whereby ships lying in the Thames can be equipped with television receivers for the duration of their stay. The installation charge is 35/- and the rental 3/4 per day.

Wired Television.—A long-term agreement has been made between Broadcast Relay Service, Ltd., and Electric & Musical Industries, Ltd., to pool their wired television research and techniques. The arrangement envisages the participation of radio retailers in existing or new television relay services operated by B.R.S.

Pye (Canada), Ltd., of Ajax, Ontario, announce that their director, W. Jones, has been appointed Controller of Radar Production in the Electronics Division of the Department of Defence Production in Ottawa. He will retain his directorship of Pye (Canada), Ltd.

We are advised that J. H. Head, commercial manager of Sydney S. Bird & Sons, makers of Cyldon components, has joined Advance Components as general manager.

Burndep, Ltd., have opened a new factory at Erith, Kent, which is to house the company's Electronics Division.

Telerection, Ltd.—A new factory—Antenna Works, St. Pauls, Cheltenham, Glos.—has been acquired by Telerection, Ltd., whose offices will for the present remain at 12, Suffolk Parade, Cheltenham.

Valradio, Ltd., inform us that their projection television receiver has been accepted for inclusion in the South Bank Exhibition.

MEETINGS

British Sound Recording Association

Presidential address by C. E. Watts, at 7.0, on September 21st, at the I.E.E., Savoy Place, London, W.C.2.

Institution of Electronics

Southern Branch.—"Design Considerations for a Modern High-Fidelity Radiogram Receiver" by Lewis Williams (Electro Acoustic Developments) at 7.0 on September 5th in the Lecture Hall, Central Library, Portsmouth.

Television Society

Engineering Group.—"Slot Aerials" by H. Page (B.B.C. Research Dept.) at 7.0 on September 21st at the Cinema Exhibitors' Association, 164, Shaftesbury Avenue, London, W.C.2.

Society of Relay Engineers

"Television Relay by Wire" at 2.30 on October 2nd at the E.M.I. Institute, 10, Pembroke Square, London, W.2.

British Institution of Radio Engineers

Annual general meeting at 6.30 on September 26th at the London School of Hygiene and Tropical Medicine, Keppel Street, London, W.C.1.

SHORT-WAVE CONDITIONS

July in Retrospect : Forecast for September

By T. W. BENNINGTON *

DURING July the average maximum usable frequencies for these latitudes decreased somewhat, both by day and night, as compared with those for June. Daytime working frequencies remained about the same as during the previous month, being higher than had been expected. 17 Mc/s was usually the best received daytime frequency for east/west paths, though those up to 22 Mc/s were frequently usable, and U.S.A. amateurs on 28 Mc/s were audible on at least one occasion. For north/south paths 22 Mc/s was about the highest regularly usable frequency, though here again higher frequencies were sometimes receivable. At night 11 Mc/s was usually workable till after midnight, and 9 Mc/s the night through.

Sporadic E was very prevalent, and a considerable amount of amateur communication on 28 Mc/s with certain European countries was noted as occurring by way of this medium.

The month was notable for the amount of v.h.f. reception which occurred by means of (presumably) tropospheric refraction. Dutch and German stations on 89-94 Mc/s were very frequently received, as also were French stations on 42 Mc/s.

Sunspot activity was, on the average, considerably lower than during the previous month.

Though several ionospheric storms occurred only one of these had really serious effects upon communications, namely, that which occurred during the period 1st-4th. The other disturbances occurred during 16th-18th, 22nd-23rd, and 16th-31st. Only one Dellinger fadeout has so far been reported, i.e., on 4th at 1255-1440 g.m.t.

Forecast: During September the daytime m.u.f. for these latitudes should increase considerably, and that for night-time decrease somewhat, as compared with con-

ditions during August. Daytime working frequencies for long-distance communication should increase generally, though 17 Mc/s will probably be about the highest regularly usable frequency for east/west circuits, with 21 Mc/s, or slightly higher frequencies, sometimes usable. Over north/south circuits frequencies up to 23 Mc/s should be regularly, and those up to 30 Mc/s sometimes, usable. At night 9 Mc/s should be regularly usable up to midnight, and 7 Mc/s thereafter over east/west circuits, whilst over north/south circuits 11 Mc/s should be regularly usable till midnight, and 9 Mc/s thereafter.

Sporadic E is likely to decrease somewhat in the frequency of its occurrence, though some medium-distance transmission on exceptionally high frequencies will probably be possible by way of this medium. Working frequencies for medium-distance communication by way of the regular layers will be somewhat lower than during August, both by day and by night, and such communication will take place by way of the E or F₁ layers for only a short period daily.

The curves indicate the highest frequencies likely to be usable over four long-distance circuits from this country during the month.

* Engineering Division, B.B.C.

Educational Filmstrips

THE 35-mm filmstrips on technical subjects produced by Mullard with the co-operation of the National Committee for Visual Aids in Education, have already been mentioned in *Wireless World*. There are now three additions to this series. "The Story of Radio," 35 frames in black and white, traces the history and development of radio and explains in simple terms how a broadcast programme (sound only) is transmitted and reproduced. It is suitable for pupils in the 11-16 age group and costs 10s. "The Cathode Ray Tube," however, occupies two filmstrips and is designed for older and perhaps more specialized audiences in technical schools and colleges. The first part, 29 frames in colour (price £1), is concerned with history, development and general principles, while the second part, 30 frames in black and white (price 10s), deals with construction and manufacture.

These three are distributed by Unicorn Head Visual Aids, Ltd., of Broadway Chambers, 40, Broadway, Westminster, London, S.W.1.

Typical frame from the filmstrip describing the history, development and general principles of the cathode ray tube.

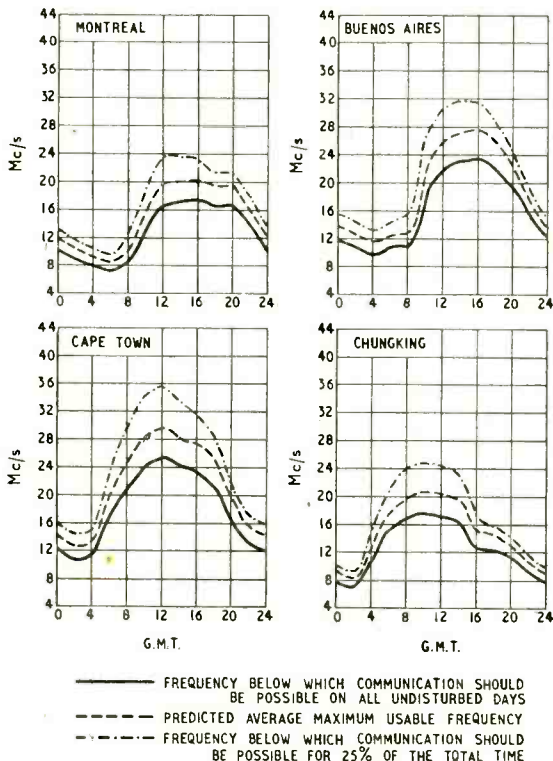
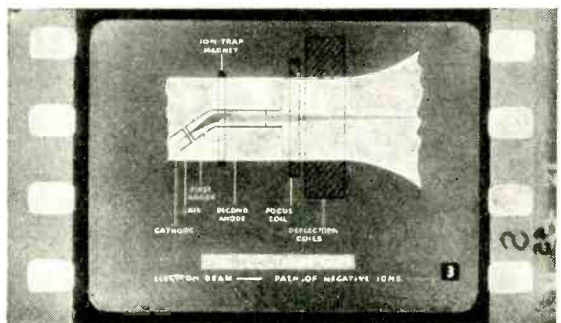

Modifying "Surplus" Meters

Two Useful Instruments from an Ex-Government Indicator

By W. H. CAZALY

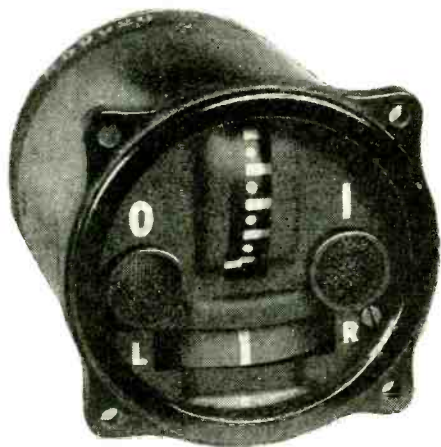

Visual Indicator Type 3 (10Q/4)

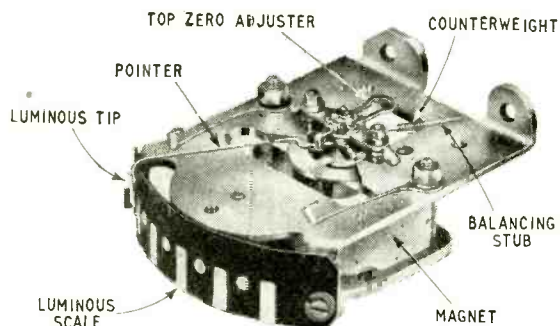

Fig. 1. Of the two movements in the indicator, this one has a linear characteristic and can be converted into a low-current meter.

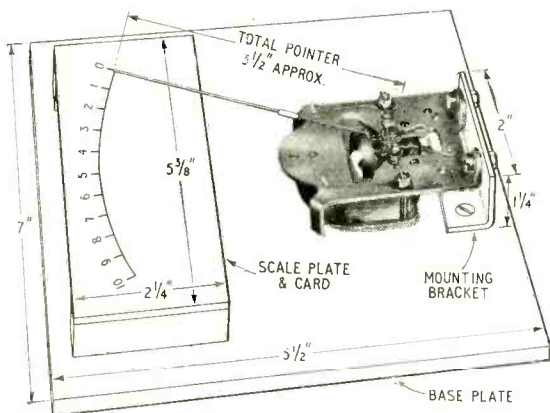

Fig. 2. Suggested form of construction for the modified meter.

CERTAIN instruments obtainable quite cheaply from Government "surplus" sources contain moving-coil movements which can be modified to provide linear-scale and centre-zero indicators of general utility. These movements are often very well made, and it seems a pity to regard them as "scrap."

As an example, the Visual Indicator Type 3 (10Q/4), obtainable for a few shillings at the time of writing, contains two moving-coil movements. Originally this was an aircraft instrument used in blind approach systems. One movement, the L-R, is a sensitive centre-zero indicator with flat pole faces, which can be used as a null indicator in bridge and other measuring circuits. Since the pole faces are flat, the characteristic is not linear, so that it is not very suitable as a "meter," but it makes a useful galvanometer with a deflection (when a new long pointer is added) of about 1½ in on either side of the central zero for about 30 μA. Currents of the order of 0.5 μA are quite detectable. It is heavily damped, and the working forces are so small that slight vibration (gentle tapping) is advisable to make the pointer return exactly to zero over the last ½ in adjacent to the zero mark. Its modification into a bench galvo is quite easy, on the lines which will be described in respect of the other movement.

The other movement (Fig. 1 shows how it appears when taken out of the instrument) has curved pole faces, with a linear characteristic over about 80°, so that it can be converted into a low-current meter such as a 0-750 μA or a 0-1 mA indicator.

It is proposed to outline, as a typical example, the conversion of this linear movement into a single-range 0-1 mA meter with a gratifyingly long scale (about 5 inches). If the principles of construction in this simple example are grasped, it should not be difficult for the experimenter to utilize these and similar movements in test instruments of various kinds.

First, a warning. Robust as moving-coil movements appear to be, it must always be borne in mind that the fine steel pivot points have considerable deforming pressure per unit area exerted on them if the pointer is not handled very gently indeed. Wood blocks should be at hand to rest the movement when it is taken out of the instrument and keep its weight off the pivot assembly; the pointer may be moved or steadied by means of a fine camel-hair artists' brush. All work done on the movement *must* be carried out on a clean surface scrupulously clear of dust, and the worker's hands must be clean; a good idea is to work on a large sheet of white paper pinned on a wooden table, with direct daylight as the illuminant. The equipment required other than the kind normally found in a small workshop comprises fine pointed tweezers, a sharp razor blade, sharp nail scissors, a camel-hair brush, a tube of Durofix (celluloid cement), and a scrap of Chatterton's compound, with a small solder-

ing iron for the melting of the compound. A jewellers' eyeglass is also a convenience, for close inspection of fine operations.

The first step consists of the construction of all the parts other than the actual movement, and assembling them ready to have the movement fitted. Ideas will vary about the form of the final instrument, but, assuming that a plain 0-1 mA meter is to be the final outcome, the author's suggestions illustrated in Fig. 2 may be useful. To outward appearances the meter will look like a shallow box made of non-magnetic material, as shown in Fig. 3. The top and sides form a removable cover, which can be taken off the base of the box, with a window over the scale, a zero adjuster, and the terminals. The base of the box constitutes the main base plate on which are mounted the scale plate, the movement, and the shunt. The cover, scale plate and base plate are carpentering jobs and should be constructed first, accurately and neatly. Plywood $\frac{1}{4}$ inch thick is quite suitable, but other materials, such as Paxolin, Bakelite, aluminium, etc., can be used, as long as they are non-magnetic. The movement mounting bracket is of stout brass or aluminium.

Next, a new pointer, which is to be added to the existing pointer of the movement, should be prepared. It consists of a thin, straight piece of hollow grass stalk, about $2\frac{1}{2}$ in long, gathered at the end of the autumn when Nature has turned it into a thin-walled, very light but remarkably strong, tube of cellulose fibre. Referring to Fig. 4, a short sleeve, about $\frac{1}{2}$ in long, made out of wider grass stalk, is slipped for about $\frac{1}{8}$ in over the butt end of the longer stalk, being secured with a tiny touch of Durofix. The open end of this sleeve will go in due course over the prepared end of the existing movement pointer, so the choice of stalks of suitable thickness should be carefully made after inspection of the movement pointer. When made, the new pointer is brushed with india ink and set aside to dry thoroughly for an hour in a warm place.

While it is drying, the scale card can be prepared. The total length of the modified pointer, from tip to pivot, can be fixed at $3\frac{1}{2}$ in, which will give a scale length of about 5 in. With this $3\frac{1}{2}$ in as radius, an arc is drawn to subtend an angle of 80° on a piece of Bristol board. The arc is then divided into ten parts (each 8°), and these divisions can each be further divided by eye into five sub-divisions. The ten divisions are then marked 0 to 10, from right to left, and the drawing is inked in. A light pencil line is drawn from the centre of the scale (the 5 mark) to the centre on which the arc was drawn, to assist later in placing the card in the correct position on the scale plate. The scale card is then cut to fit the scale plate with a small amount of play and stuck to the plate so that the central pencil line lies over the medial line of the base plate. Touches of glue at the four corners of the card will be sufficient to hold it without the buckling that might ensue if a lot of glue were used. The card must, of course, be dead flat.

Mounting the Movement

Now the movement can be dealt with. It is mounted on a non-magnetic metal bracket of fairly rigid construction (duralumin or hardened brass or aluminium $\frac{3}{32}$ in thick are suitable), in such a way that (a) the top assembly plate of the movement is level with or very slightly above the surface of the scale card and parallel with it; and (b) the pivot of the pointer is over the spot where the scale arc centre would be. Allow-

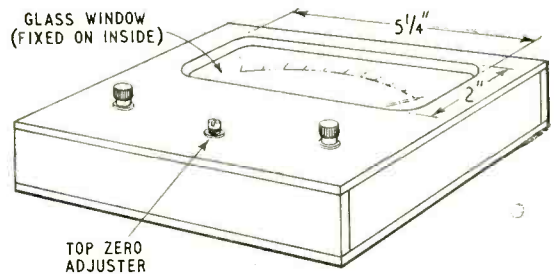
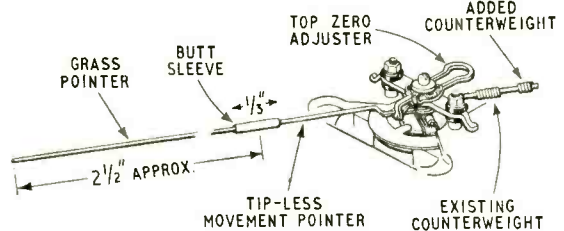

Fig. 3. The modified meter in its housing. The top and sides are made as a removable cover which fits on the base plate (Fig. 2).

Fig. 4. Detail of the movement, with the extended pointer and extra counterweight.



ing a slight amount of play in the bolt holes of the bracket will enable it and the movement to be positioned by eye with adequate accuracy.

The bent-over luminous tip of the existing pointer is snipped off with a really sharp pair of nail scissors, proceeding very cautiously in order to avoid strain on the pointer and steadying it with the camel-hair brush against jerking or violent swinging as it is cut. Next, the prepared grass pointer is added to the now tipless movement pointer by slipping the hollow butt sleeve over the existing pointer (with a trifle of Durofix inside the sleeve). If the choice of grass stalks has been intelligent, the sleeve should slip on quite easily but not too loosely. Grass is cheap and several experiments in making these grass pointers are worth while. Until the cement inside the butt sleeve has dried, the now long pointer should be supported about $\frac{1}{2}$ in above the scale card by suitable packing. When the Durofix is really dry (after about an hour), the packing can be removed and the new long pointer should then swing freely over the scale card, equidistant from its surface at all points. Slight final adjustment of the movement with the play in the bolt holes of the bracket will facilitate obtaining a nice parallel swing. The pointer should be moved by blowing it gently or pushing it with the brush. The pointer can be brought to the zero end of the scale (to the right, notice, not the left) by setting the top zero adjuster central and moving the bottom adjuster to bring the tip over the zero mark on the scale.

As soon as the assembly is tilted, the pointer, at this stage, will swing away from the zero mark, because it is not yet balanced by a counterweight on the balancing stub on the other side of the pivot. First the pointer is cut so that its tip just overlaps the scale arc (not projecting above the sub-division marks). This is done by steadying the pointer with the brush against the scale card and cutting off the required amount from the tip with a clean, chisel-like

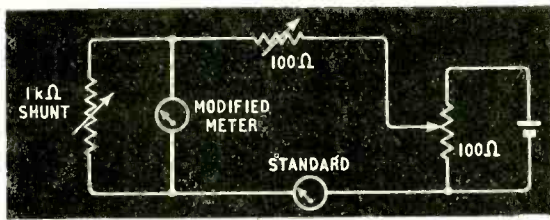

Fig. 5. Circuit for determining the shunt necessary to give full-scale deflection with 1 milliamp.

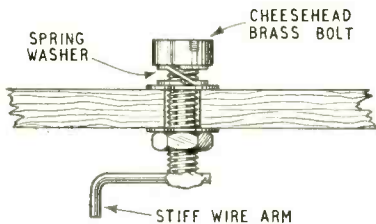

Fig. 6. Device made from a 2 B.A. bolt for external operation of the zero adjuster.

action of the razor blade. Unless the grass stalk is exceptionally thin and light, the pointer will be still unbalanced and will require added counterweight. The counterweight consists, in these instruments, of a fine helix of copper wire slipped over the balance stub. It is not advisable to try shifting the existing counterweight since this is fixed with cement, and there will be risk of damaging the movement while loosening it. A small helix of 36 or 34 s.w.g. copper wire is prepared by winding $\frac{1}{16}$ in along a darning needle. This additional counterweight is slipped over the free end of the balancing stub. A tiny touch of Chatterton's compound will fix it. Cement or glue

which dries is not very suitable, since the drying-out of moisture will upset the balance a little; the compound hardens by cooling. The small soldering iron is used to melt the compound. The added helix is shifted on the stub until its position is such that the pointer tip does not swing away from the zero mark by more than about $\frac{1}{16}$ in when the assembly is tilted sideways through a right angle.

The meter, as it can now be called, will show full-scale deflection of 80° with current between 600 and 700 μA passing through the coil. To make it show full-scale deflection with 1mA passing, a shunt is added. The circuit shown in Fig. 5 is employed for the purpose. A variable wire-wound resistor of $1\text{k}\Omega$ maximum is used temporarily as the shunt and its value is adjusted until the meter under construction shows full-scale deflection when 1mA is indicated on the instrument used as the standard. Then the shunt is accurately measured, and a fixed wire-wound resistor of small size is constructed to have exactly the same value and is wired permanently across the coil leads of the new meter.

Save for the connection of the movement leads to the terminals in the cover, and the fitting of some externally operable zero-adjusting device, the instrument is now complete. The simplest kind of zero-adjusting device would consist of a $\frac{1}{2}$ -in diameter hole in the cover, with a sliding lid, over the top zero adjuster of the movement, and something could be inserted through this hole to push the adjuster about. Details of a more elegant device, somewhat resembling the kind used in commercial moulded cases, is shown in Fig. 6. The position of this arrangement is such that the bent end of the stiff wire soldered to the end of the 2 B.A. bolt just engages in the slot of the zero adjuster without fouling the balance stub beneath it.

Standard Frequency Transmissions

Guaranteed Accuracy of B.B.C. Stations

THE B.B.C. radiates four broadcast transmissions that are guaranteed to have a frequency stability of ± 1 part in 10^6 . These standard frequency transmissions are the Light Programme transmission from Droitwich on 200 kc/s, which is broadcast daily from 0800-2300 G.M.T., GRO on 6.180 Mc/s in the 49-metre band, GSB on 9.510 Mc/s in the 31-metre band, and GSV on 17.810 Mc/s in the 16-metre band. Of these four, the 200-kc/s transmission is particularly useful for those in Europe requiring a guaranteed standard, for, owing to the wavelength used and the high power output of the transmitter, it can be received in most places. Although the frequency is guaranteed to be within 1 part in 10^6 of its nominal value, it is usually maintained to within ± 1 part in 10^7 , and can therefore be used with confidence for measurement or comparison to this high order of accuracy. For example, the B.B.C., in conjunction with the British Forces Network in Germany, uses this 200-kc/s transmission for maintaining the German transmitters precisely on their nominal frequency of 1214 kc/s, which they share with the B.B.C.'s Light Programme transmitters in the United Kingdom.

The 200-kc/s transmission is also used by the B.B.C. to control the carrier frequency of a number of low-power, unattended transmitters operating in the United Kingdom on the Third Programme channels of 647 and 1546 kc/s. Briefly, the method used is to pick up the signal from Droitwich on a t.r.f. receiver which is followed by a limiter and a chain of frequency dividers having an overall division ratio of 200:1. The 1-kc/s output from the dividers is compared with the transmitter frequency in a control

unit, which automatically adjusts the master oscillator frequency by an appropriate amount and in the right sense so as to correct any frequency error.

The frequencies of the standard transmissions on short waves (GRO, GSB, GSV) are maintained to well within ± 1 part in 10^6 of their nominal values. In view, however, of the Doppler effect, interference, and vagaries of the propagation path, it is not expected that these transmissions will be suitable for measurements requiring an accuracy better than ± 1 part in 10^6 . Unlike the 200-kc/s standard, these transmissions are not radiated according to a fixed schedule but at times which vary seasonally according to the requirements of the Overseas Service.

Apart from these standard transmissions, the frequencies of all the B.B.C.'s medium-wave stations are usually maintained to within ± 1 part in 10^7 of their nominal value. The short-term stability is generally better than ± 5 parts in 10^6 . Though no guarantee is given that this higher-order stability will be maintained, it is very unusual for the frequency to be outside these tolerances. Similarly, the frequencies of B.B.C. short-wave transmissions are accurate to ± 30 parts in 10^6 , as agreed at the Atlantic City Conference in 1947. In practice, however, it is rare for the frequency to exceed the limits of ± 10 parts in 10^6 , although such an accuracy is not guaranteed.

It may be noted that the 440-c/s tuning note radiated immediately before the opening of the B.B.C. Third Programme, and the 1,000-c/s note preceding the start of the Home Service and of the Light Programme are maintained to the same accuracy as that of the Droitwich 200-kc/s transmission.

Manufacturers' Products

New Equipment and Accessories for Radio and Electronics

Radio Tuner Unit

CONSTRUCTORS of high-quality amplifiers will be interested in the radio unit produced by C. T. Chapman (Reproducers), Ltd., of Riley Works, Riley Street, Chelsea, S.W.10. It has a four-stage superhet circuit (ECH42, EF41, EBF80) with two-position variable selectivity (7 kc/s and 10 kc/s) and amplified a.v.c. The makers claim very low noise and distortion and tell us that differential distortion is non-existent. The three controls are for tuning, wave range and selectivity—in addition to the normal medium- and long-wave bands there is a short-wave range of 16-50 metres. An output of approximately 250mV is available into 50-500 kΩ. External power supplies are needed for the heaters, which consume 1 A at 6.3 V, and h.t., which takes 20 mA at 250 V. Finished in stove enamelled silver lacquer and complete with an illuminated glass scale and bronze escutcheon, the tuner costs £12 plus £5 6s 8d Purchase Tax.

Electric Drill Suppressors

FOR eliminating the interference set up by their "Wolf Cub" drill, Wolf Electric Tools, Ltd., of Pioneer Works, Hanger Lane, London, W.5, have produced two suppressors, one for sound broadcast wavelengths and the other for television. The first, which costs 23s 6d,

is housed in an earthed metal case and is fitted at one end with a length of cable for connection to a three-pin mains plug, the other end being free to take the drill cable. The television suppressor, however, has to be fitted inside the drill body and drill owners are asked to send their machines to the nearest Wolf service depot where the job will be done for 8s 6d including return postage.

Ultrasonic Soldering Bath

TO permit the tinning of small and awkwardly shaped aluminium parts which cannot be handled by their ultrasonic soldering iron, Mullard, Ltd., of Century House, Shaftesbury Avenue, London, W.C.2, have introduced an ultrasonic soldering bath. It works on the same principle as the iron in so far as the oxide is removed by ultrasonic vibration coming from a magnetostriction transducer, but here the parts to be tinned are immersed in molten solder and the ultrasonic energy is applied through this. The bath consists of a container, $\frac{1}{2}$ in across and $\frac{1}{4}$ in deep, which is heated by a conventional resistance winding and agitated ultrasonically by a magnetostriction element composed of iron alloy laminations. It has been designed to operate from the same power unit as supplied with the iron—an amplifier which maintains a 20-kc/s oscillation by means of two coils on the magnetostriction element.

TRIX

Quality

SOUND EQUIPMENT

FOR

HIGH POWER INSTALLATIONS

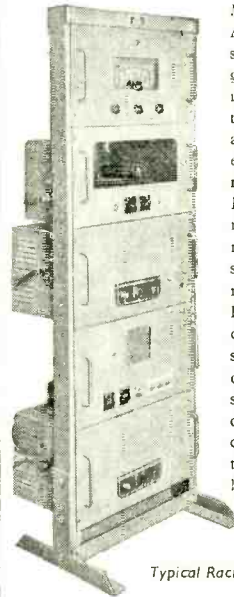

Typical Rack-Mounted Equipment

Most of the Trix Amplifiers and associated radio and gramophone units, mixers, remote control relays, etc., are designed to be easily adaptable to rack mounting. From the wide range of Trix equipment and accessories the requirements of any High Power installation can be met. We shall be pleased to outline a suitable scheme — without obligation — on receipt of details of the type of installation you need.



Reflex HORN SPEAKER

This is a heavy duty reflex type horn speaker suitable for both speech and music reproduction, having an air column 48in. in length, with flare diameter of 25in.

Full details of these and other models in the large Trix range of Sound Equipment available on request. Send for latest catalogue and price lists.

Meet us at
THE RADIO SHOW
EARLS COURT
LONDON Aug. 29-Sept. 8

STAND 23

THE TRIX ELECTRICAL CO. LTD.
1-5 Maple Place, Tottenham Court Road,
London, W.1. Phone: MUSEum 5817
'Grams & Cables': "Trixadio, Wesdo, London."

AMPLIFIERS · MICROPHONES · LOUDSPEAKERS

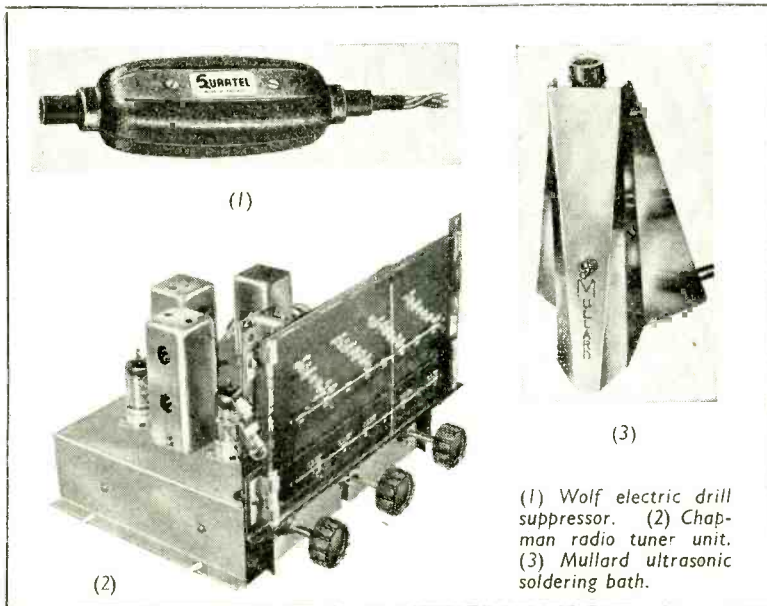

(1) Wolf electric drill suppressor. (2) Chapman radio tuner unit. (3) Mullard ultrasonic soldering bath.

RANDOM RADIATIONS

By "DIALLIST"

E.H.F. Mystery

AFTER THE LONG and thorough comparative trials of a.m. and f.m. from Wrotham, the Postmaster General's announcement in the House of Commons came as something of an anticlimax. The betting was on f.m., for the B.B.C. had made no secret of its own views and any who had had the chance of comparing the twin transmissions must have been in full agreement with them that for high-fidelity broadcasting on metre waves f.m. is the better of the two systems in fringe areas. The P.M.G. left us all rather gasping by his statement that he was advised that, in view of a certain recent development, it would be unwise to decide right away in favour of either system; he would say nothing of the new development, save that it had not yet been fully tried out. And there, at the moment of writing, we still are. The B.B.C. people professed no knowledge of it, so it must be something worked out by the Post Office engineers. One cannot believe that they would have given the P.M.G. the advice they did if they had not felt fairly sure that they had something rather good. What that something is is anybody's guess.

Acoustics

THE ACOUSTICS of the Royal Festival Hall, one reads, are so excellent that every sound is heard at its full value in any part of it. So far as broadcasts from the hall are concerned, I would say that one of its most striking acoustic features is the way in which it does justice—and more than justice—to the "ackin' corf." Clear through (or even over) loud musical passages come these bronchial barks; when the conductor stills the orchestra to a pianissimo passage, the coughs do not follow suit but continue their loud *obbligato*. Clearly, somebody ought to do something about it; but what? Tactful and charming attendants might move silently on rubber soles to administer lozenges. Alternatively, human gorillas, with bulging muscles, and also rubber-soled, might be employed to warn the persistent cougher: "One more cough out of you . . ." and then, if need be, to chuck him out. The experts of

the B.B.C. might invent a cough-filter for the microphone. Those who design our receivers would make sure of a terrific selling point could they devise a cough-eliminator which might be switched in when required. What an opportunity, if ever we come (which Heaven forbid) to the commercial programme, for the sponsors—"You have just been listening to barkless Bach: a cantata without a cough. Every member of the audience was supplied with Chisclers' Comforting Coughdrops for Chesty Chappies."

Sponsored Television

SPEAKING of sponsored programmes reminds me that I have had several letters recently from both Americans and Britons in the U.S.A. in which reference has been made to the programmes provided for viewers in the States. I gather that there is no little dissatisfaction with the matter provided by the advertisers responsible for the programmes. Some recent items have been, to say the least of it, not in the best of taste and I hear that one gave such widespread offence that a good many parents with children in their homes got rid of their receivers forthwith. Parenthetically, I would doubt whether that drastic step

achieved its object, for, if I know anything of "Junior" and his sister, they would make prompt arrangements to continue their viewing in the homes of young friends where television receivers were still *in situ*! Those who support the idea that we should go in for sponsored television might give a little thought to its not very pleasant possibilities.

That 15 Per Cent

WHEN THE GOVT. lightly gave as the reason for proposing to appropriate 15 per cent of the net licence fees that it was only just that the listener and the viewer should make some contribution to the general revenue in return for their entertainment, it must have been forgotten that both have made and continue to make substantial payments into the Government's kitty. When you buy your broadcast or television set you pay a considerable sum to the Treasury in the form of Purchase Tax. And whenever a new valve or c.r.t. is acquired, you pay your by no means small whack to the general revenue in the same way. Let's see how it works out in the form of annual contributions. Putting it on the low side, we might take the average P.T. on a wireless set at £7 10s. Give the set a life of five years and that represents £1 10s per annum. Tax on the renewals needed during that period won't be less than 5s a year—and may come to a great deal more. John Listener, then, is already putting at least £1 15s a year into the pool, in addition to the cost of his receiving licence. John Viewer starts



"WIRELESS WORLD" PUBLICATIONS

	Net Price	By post
FOUNDATIONS OF WIRELESS. M. G. Scroggie, B.Sc., M.I.E.E. Fifth Edition. (<i>Ready shortly</i>)	12/6	12/11
RADIO VALVE DATA: Characteristics of 2,000 Valves and C.R. Tubes. 2nd Edition.	3/6	3/10
TELEVISION RECEIVING EQUIPMENT. W. T. Cocking, M.I.E.E. 3rd Edition	18/-	18/8
SHORT-WAVE RADIO AND THE IONOSPHERE. T. W. Bennington. 2nd Edition	10/6	10/10
WIRELESS SERVICING MANUAL. W. T. Cocking, M.I.E.E. 8th Edition	12/6	12/11
RADIO LABORATORY HANDBOOK. M. G. Scroggie, B.Sc., M.I.E.E. 5th Edition	15/-	15/6
BASIC MATHEMATICS FOR RADIO STUDENTS. F. M. Colebrook, B.Sc., D.I.C., A.C.G.I. 2nd Edition	10/6	10/10
WILLIAMSON AMPLIFIER: Articles on Design of a High-quality Amplifier	3/6	3/9
RADIO DATA CHARTS. R. T. Beatty, M.A., B.E., D.Sc. 5th Edition—revised by J. McG. Sowerby, B.A., M.I.E.E.	7/6	7/11

A complete list of books is available on application

Obtainable from all leading booksellers or from

ILIFFE & SONS LTD., Dorset House, Stamford Street, London, S.E.1.

with a much larger amount of P.T. when he buys a television set: about £20 would probably be a fair average—say £4 a year spread over the five years of his set's life. With his 15 to 20 valves and his c.r.t., I'd put the P.T. on his necessary replacements at not less than 12s 6d p.a.—and that gives an annual total per viewer of £4 12s 6d, again in addition to his licence fee. On the whole, I feel that our 11½ million listeners and our round about a million viewers are already contributing pretty well to the country's general revenue.

Problem Corner

IF ONE MAY JUDGE from the number of replies that each of them brings in, readers seem to like the little headaches that I offer them from time to time. Every one of them is founded on an actual experience. Here's a recent adventure. I was in the drawing room of a completely non-technical friend. The set, an up-to-date mains superhet of first-rate make, was switched on for the nine o'clock news. From moment to moment the announcer's words were blotted out by shattering volleys of *staccato* interference, sounding rather like the exhaust noises of an unsilenced motor bike travelling at great speed. The source of this interference was obviously something electrical in the room, for the house itself was completely detached from others and everything in other rooms was switched off. In this drawing room there were working at the time: diffused lighting from three concealed 80-watt fluorescent tubes of the kind-to-complexion type, an ordinary 2-kW electric fire (it was a chilly evening), a 600-W bowl fire, an electrically heated coffee pot and three 60-W lamp bulbs. Given that you had no measuring or other instruments available: (1) How would you have set about tracking down the interference? (2) Given that the bowl fire was guilty, what do you think was the cause of it? I warn you that it was something that I hadn't come across before.

GENERALLY speaking, the individual can do little in response to the majority of appeals made in the interest of national economy. But the salvage of waste paper is an exception; *everyone* can help. Of course, paper is *Wireless World's* raw material; equally, of course, we have an axe to grind, but we will not apologize for re-echoing the appeal being made by the Waste Paper Recovering Association for renewed salvage efforts.

PLUGS SOCKETS CROCODILE CLIPS SIGNAL LAMPS

SWITCHES

POTENTIOMETERS

RESISTORS

VALVE HOLDERS

T.V. SUPPRESSORS

TEST PRODS

KNOBS

FOR OVER



25 YEARS

'THE CHOICE OF CRITICS'

REGD. TRADE MARK

THE House of Bulgin extends a very warm welcome to all our Friends, to visit Stand No. 2 at the National Radio Show. For over a quarter of a century we have continued to give service, especially in times of difficulty, Technical advice when required, and unsurpassed quality of manufactures at all times.

With a range of over 2,000 different types of components which include 15,000 piece parts, an enthusiastic staff, and experience dating since the inception of Broadcasting we are sure Design and Production Engineers will find many new Bulgin Products displayed, and our Technical Engineers ready to give assistance on any problem of manufacture.

AUG. 29th to SEPT. 8th—VISIT STAND No. 2
NATIONAL RADIO SHOW, EARLS COURT

SEND FOR NEW CATALOGUE No. 190/W.W.
PRICE 1/- POST FREE

MANUFACTURERS OF RADIO & ELECTRONIC COMPONENTS

A.F. BULGIN & CO. LTD
BYE-PASS ROAD BARKING
TELEPHONE Rippleway 3474 (5 lines)

JACKS
JACK PLUGS
FUSES
FUSE HOLDERS
THERMAL FLASHER UNITS
MICRO-SWITCHES, ETC., ETC.

UNBIASED

By FREE GRID

Plea for Push Buttons

RADIO has had its fashions in receiver design just like women's clothes and some of them have been almost as silly, but on the whole there has been a sound reason for even the most ephemeral of wireless fashions. As an instance of this I would point to the popular reflex design of the early days of broadcasting. The high price of valves forced this compromise on us and great ingenuity was exercised in getting round some of its more glaring snags; how glaring they were was pointed out at the time by this journal under the apt title of "Rocks That Wreck Reflexing."

Other fashions, after a brief innings, have virtually disappeared only to return later in vastly improved form to become a permanent feature of design, the most outstanding instance of this being the superheterodyne. Push-button tuning threatens to become another instance of it. P.B.T. first made its appearance in pre-war years and, despite a lot of teething



A leaning towards the bar

troubles, it bade fair to become a permanency in all sets, but the war changed all that. It is, however, now starting to stage a comeback but a very cautious one so far. Nevertheless, I venture to prophesy that in its greatly improved and more stable form it will eventually sweep all other forms of tuning off the market. The sooner it does so the better, for it is, in my opinion, the only tuning system which is technically sound and at the same time completely womanproof.

If you pause for a moment to think instead of sitting down to write an indignant letter to the Editor, you will see why this is so. In the case of the ordinary system of variable tuning everything must of necessity be a compromise. If, for instance, the degree of aerial coupling and the LC ratio of the tuning circuits be just right for receiving a station at one end of the tuning scale, they certainly won't be just right at the other end;

the aerial coupling is, of course, set at a compromise value for all stations and the LC ratio varies from station to station with the tuning. Much the same thing applies to all the other possible "variables" in the receiver. But with pre-set P.B.T. a woman or other completely untechnical user can adjust a large number of "variables" simultaneously by simply pushing a button having the requisite large number of cams on the rod attached to it. Everything can, in fact, be made "optimum" for receiving a particular station.

My thoughts in this matter are, of course, far from original; they are just self-evident. But I do not doubt that those with a leaning towards the Bar can quickly work up a convincing set of counter-arguments to put before you who form the jury; in fact, I could do it myself.

National Radio Centre

THAT portion of the South Bank Exhibition which lies between the County Hall and Hungerford Bridge is, I believe, already earmarked for the erection of some sort of Government building, otherwise I would have suggested that a new and up-to-date Broadcasting House be erected there. Already, however, there is talk of clearing the unsightly mess on that portion of the south bank of the Thames which lies between Waterloo and Blackfriars bridges so that it may be made into a fitting counterpart of the Victoria embankment on the other side of the river.

So far only vague and tentative suggestions have been made as to the nature of the buildings to be erected there. But now that the National Concert Hall has been built and the Queen has laid the foundation stone of the National Theatre on the adjacent section of the river bank, it would surely be fitting for the whole of the south side of the Thames between Hungerford and Blackfriars bridges to be turned into a national entertainment centre. What more fitting than that the National Concert Hall and National Theatre should be flanked by a super radio and television centre which would make New York's Radio City look like a penny gaff. Next year, which sees the B.B.C.'s 30th birthday and also the 30th anniversary of the first radio exhibition at the Horticultural Hall, would be a fitting time to lay the foundation stone.

The site is ideal in every way even as to size, being not too big or too small. There would be ample room for spacious studios as well as public

listening and viewing halls. There would even be room for the administrative offices, although it would be preferable that they be left in the human rabbit warren at Portland Place and allowed to overflow into the present studios. The opportunity of acquiring such a magnificent position for broadcasting H.Q. is not likely to occur again for a thousand years.

Television Recording

IT is astonishing what a large number of "tape" recording and reproducing outfits—to say nothing of parts for making them—is available nowadays. The makers of some of them stress the fact that among their many uses is the bottling of broadcasting programmes for future consumption, but, so far as I know, none of them incorporates a time-switch so that you can pre-set the whole apparatus to can a programme which is due to go on the air at a time when you can't be at home to listen. Eventually, of course, as I've always demanded, every receiver will incorporate a recorder and time-switch as an integral part of it. At present, however, the expense of doing this would be too great, and the resultant set, complete with P.T., would be far beyond the means of all save dentists and others who earn their daily crust by the cold sweat on other people's brows.

Although, as I have already mentioned, recording units are now available in considerable numbers, I think I am correct in saying that nobody has yet made any attempt to produce one for the vision part of television programmes. I am not, of course, thinking of apparatus for recording television as actual pictures on cine film, but as modulated electrical impulses on disc or tape. Baird recorded vision on discs long years ago and there is no fundamental reason why the same broad principles should not be used for recording it on tape. It is no business of mine to take the bread out of the mouths of inventors and manufacturers by giving full technical details here and, therefore, much against my will, I refrain from doing so.



Cold sweat